

Status: 04/2025



**NEW**  
Applicators HQ



Print and  
apply systems  
for industrial operation

**HERMES Q**

Made in Germany



## Data security in label printing

Modern manufacture sees marking systems work autonomous, interact among each other, with host computers or a plant control unit. Data security is a key issue. The integration of components, their administration and authentication are sensitive tasks demanded from the corporate IT. cab systems developed for printing and applying labels provide proper features by default, fairly protecting your data in a network.



Permissions can be assigned to users and restricted by passwords.



Firmware updates are verified for integrity before installation.



Access to network services (HTTP, FTP, VNC, OPC UA etc.) is possible only for users with authorization. Network services can be switched on or off.



Network protocols can be encrypted using TLS/SSL. To connect securely in a network, a certificate as required is installed in the device ex factory.



WLAN can be switched on or off. WPA2, WPA2 Enterprise and WPA3 levels of security are supported.



Printers in a network can be authorized securely. IEEE 802.1X network standard is supported.



USB slots can be locked and access to external storage media be denied.

All the current cab printing systems are based on the same electronics and firmware. The printer language is the same, so are interfaces and memory. Any further developed operating system or driver is available immediately on every device. Resets to default settings are PIN-protected.



## Contents

<b>Page 2</b> .....	cabPROTECT
<b>Pages 4 - 13</b> .....	HERMES Q
<b>Pages 14 - 15</b> .....	Software
<b>Pages 16 - 36</b> .....	Applicators
<b>Page 37 - 38</b> .....	Tools for assembly
<b>Pages 39 - 40</b> .....	Floor stands
<b>Pages 42 - 46</b> .....	Delivery program
<b>Page 47</b> .....	cab product overview

# HERMES Q

Printing labels and applying them automatically in production lines



## The slim one

to print small labels

Label printer		HERMES Q2	
Printable resolution	dpi	300	600
Print speed	up to mm/s	300	150
Print width	up to mm	56.9	54.1
Label roll outside diameters	mm	205 / 305	
Label width	up to mm	58	



## The universal one

An industrial bestseller, providing a wide range of accessories

Label printer		HERMES Q4.3		HERMES Q4	
Printable resolution	dpi	200	300	300	600
Print speed	up to mm/s	300	300	300	150
Print width	up to mm	104	108.4	105.7	105.7
Label roll outside diameters	mm	205 / 305			
Label width	up to mm	114			



## The wide one

to print Odette, UCC and GS1 labels in logistics applications

Label printer		HERMES Q6.3	
Printable resolution	dpi	200	300
Print speed	up to mm/s	250	250
Print width	up to mm	168	162.6
Label roll outside diameters	mm	205 / 305	
Label width	up to mm	174	

## Sample applications



## Label rolls

All units can provide an unwinder for picking up rolls with maximum diameter either 205 mm or 305 mm.



## Directions to which dispense labels

All units can be designed for providing labels either to the left or to the right.



## Orientations of assembly

All the units can be rotated vertically by at most 360° or assembled in horizontal orientation.

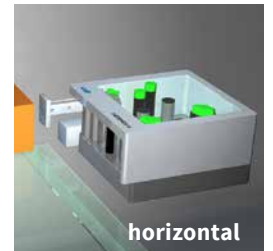
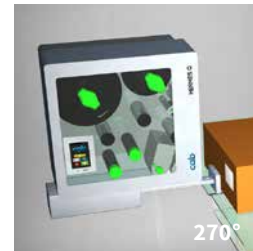
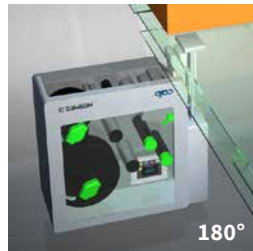
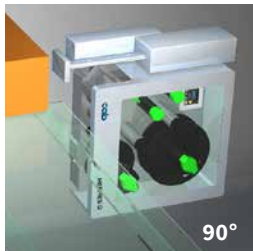
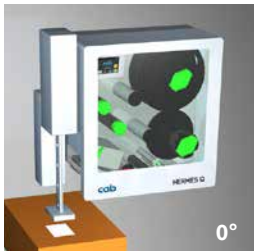

# HERMES Q in detail



## 1 Operation panel

Self-explanatory symbols are on display. The device can thus be operated intuitively and settings be configured easily.

## 2 Ribbon holder

On the basis of three-part tightening axes, ribbons can be replaced easily and quickly.

## 3 Rugged metal chassis

It is made of cast aluminum. All the parts are assembled to it.

## 4 Applicator

It is assembled to hinge pins. It can be pivoted in case of maintenance or if materials have to be replaced.

## 5 Pressing plungers

One is fixed near the chassis wall. The second one is pushed to the label margin, as far as necessary to evoke a good print image.

## 6 Print head

Units of the same width are interchangeable. Replacement requires only few steps.

## 7 Print roller

It can be removed/inserted quickly in cases of cleaning or wear.

## 8 Peel-off plate

Pivoting improves labels be applied to packages.

## 9 Label unwinder

A swing arm and an integral brake enable labels be unwound at constant force.

## 10 Liner rewinder

Subsequent to all the labels been dispensed, the entire liner tape is rewound. On the basis of a three-part tightening axle, a liner tape can be inserted and removed easily.

## 11 Pulling system

A liner tape is clamped between a draw roller and a pinch roller. Labels are dispensed using feed synchronous to the print roller.

## 12 Label sensor

Imprint is precisely set on spot on a label and materials ending detected by a transmissive or a reflective sensor.

## Accurate imprint

The smaller a label, the higher are the demands regarding the accuracy of an imprint. Print offset can be reduced by  $\pm 0.2$  mm using adjustable slip correction.

## Print heads



**Units of the same width are interchangeable.**  
**They are detected by the CPU automatically and calibrated.**  
**The print distance to the locating edge can be adjusted.**

Major data such as the operational performance, maximum operating temperature and heat energy are recorded on the print head. Data can be read at the factory.

**Print heads provided for HERMES Q2, HERMES Q4 - 300, 600 dpi**

- sharp-edge print images
- e.g. when printing small fonts and graphics on typeplates
- e.g. when printing on materials requires high energy needs

**Print heads provided for HERMES Q4.3, HERMES Q6.3 - 200, 300 dpi**  
 persistent; when labeling in rough settings and thermal direct method

## Print rollers



**Two types of materials:**

**Print rollers DR**

providing a synthetic rubber coating  
 They enable highly accurate imprint and are provided by default.

**Print rollers DRS**

providing a silicone coating  
 Product life is extra long, taken a higher print offset into account.

## Interfaces



- 1 Slot to insert a **SD memory card**
- 2 **2 USB hosts** to connect a service key, USB memory stick, keyboard, barcode scanner, USB WLAN stick, warning light, an external operation panel
- 3 **USB 2.0 Hi-Speed** to connect a PC
- 4 **Ethernet 10/100 Mbit/s**
- 5 **RS232C** 1,200 to 230,400 baud /8 bits
- 6 **Digital I/O interface;** socket connector SUB-D, 25 pins compliant with IEC/EN 61131-2, types 1+3;  
 All the inputs and outputs are isolated galvanically and protect from reverse polarity. In addition, outputs are short-circuit proof

**PNP inputs**

Start printing or labeling  
 Print first label  
 Reprint  
 Delete print job  
 Label removed  
 Stop printing or labeling  
 Label feed  
 Label rotated by 90°  
 (to be applied by applicator 4214)  
 Pause  
 Reset

**PNP, NPN outputs**

Device ready  
 Print data available  
 Initial / upper end position  
 Paper feed ON  
 Label in transfer position  
 Label application / lower end position  
 Pre-warning to a ribbon ending  
 Pre-warning to a label web ending  
 End of a ribbon and/or a label web  
 Collective error

Option:

- 7 **2 port Ethernet switch 10/100 Mbit/s**

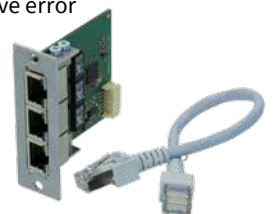







# Operation panel

**Self-explanatory symbols are on display. The device can thus be operated intuitively and settings be configured easily.**

- 1 **LED:** Power ON
- 2 **Status bar:** data reception, record data stream, pre-warning to a ribbon ending, SD memory card / USB memory stick plugged in, WLAN, Ethernet, USB slave, time
- 3 **Printer status:** ready, pause, number of labels printed in a print job, label in transfer position, awaiting external start signal
- 4 **USB slot** to connect a service key or a memory stick, to transfer data to the IFFS memory

## 5 Operation

-  Printing and applying labels in individual steps
-  Jump to menu
-  Reprint the latest label
-  Interrupt and continue a print job
-  Stop and delete all print jobs
-  Label feed



**Setup options**



**Print parameters**

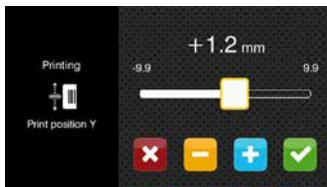

**Print offset Y**

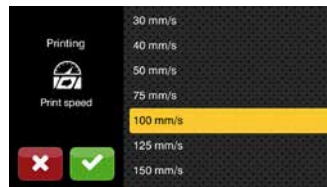

**Print speeds**

**Landscape or portrait display, depending from the orientation of assembly**



**Printer rotated by 90°**



**Video tutorials**

# External operation panel

If the operation panel of a printer cannot be accessed, an additional external one can be plugged.

Same functionality as on the printer

Landscape or portrait mode

Operability as desired on the external operation panel or on the printer

Printer connectivity: USB 2.0 Hi-Speed device

- 1 **LED:** Power ON
- 2 **USB port** to plug a service key or a memory stick, to transfer data to the IFFS memory
- 3 **Connecting USB cable** for power supply  
cab provides specified cables. Lengths are 1.8 m to 16 m.









# Accessories

Accessorial products are plugged or screwed to a printer by the customer.

Pos.	Designation	roll Ø	205	305	1.1	1.2		1.3
					HERMES Q2	HERMES Q4.3	HERMES Q4	HERMES Q6.3
2.1	SD memory card		●	●	<input type="checkbox"/>	<input type="checkbox"/>	<input type="checkbox"/>	<input type="checkbox"/>
2.2	USB memory stick		●	●	<input type="checkbox"/>	<input type="checkbox"/>	<input type="checkbox"/>	<input type="checkbox"/>
2.3	USB WLAN stick		●	●	<input type="checkbox"/>	<input type="checkbox"/>	<input type="checkbox"/>	<input type="checkbox"/>
2.4	USB WLAN stick including a rod antenna		●	●	<input type="checkbox"/>	<input type="checkbox"/>	<input type="checkbox"/>	<input type="checkbox"/>
2.6	Product sensor, 3 pins		●	●	-	<input type="checkbox"/>	<input type="checkbox"/>	<input type="checkbox"/>
2.7	Product sensor, 25 pins		●	●	<input type="checkbox"/>	<input type="checkbox"/>	<input type="checkbox"/>	<input type="checkbox"/>
2.8	I/O interface connector SUB-D, 25 pins		●	●	<input type="checkbox"/>	<input type="checkbox"/>	<input type="checkbox"/>	<input type="checkbox"/>
2.9	Warning light		●	●	<input type="checkbox"/>	<input type="checkbox"/>	<input type="checkbox"/>	<input type="checkbox"/>
2.10	External operation panel		●	●	<input type="checkbox"/>	<input type="checkbox"/>	<input type="checkbox"/>	<input type="checkbox"/>
	Connecting USB cable		●	●	<input type="checkbox"/>	<input type="checkbox"/>	<input type="checkbox"/>	<input type="checkbox"/>
2.11	Label selection - I/O box		●	●	<input type="checkbox"/>	<input type="checkbox"/>	<input type="checkbox"/>	<input type="checkbox"/>
2.12	Hand switch TR2		●	●	<input type="checkbox"/>	<input type="checkbox"/>	<input type="checkbox"/>	<input type="checkbox"/>
2.13	Foot switch		●	●	<input type="checkbox"/>	<input type="checkbox"/>	<input type="checkbox"/>	<input type="checkbox"/>
2.14	Connecting RS232 C cable		●	●	<input type="checkbox"/>	<input type="checkbox"/>	<input type="checkbox"/>	<input type="checkbox"/>
2.15	Scanner CC200		●	●	<input type="checkbox"/>	<input type="checkbox"/>	<input type="checkbox"/>	<input type="checkbox"/>

2.1		<b>SD memory card</b>
2.2		<b>USB memory stick</b>
2.3		<b>USB WLAN stick</b> 2.4 GHz 802.11b/g/n hotspot or infrastructure mode
2.4		<b>USB WLAN stick including a rod antenna</b> to extend the range of operation 2.4 GHz 802.11b/g/n + 5 GHz 802.11a/n/ac hotspot or infrastructure mode
2.6		<b>Product sensor, 3 pins</b> to be attached to a front side applicator, a vacuum belt applicator or an air jet box. Labels are triggered to be applied as soon as a product has been detached, e.g. on a conveyor belt.
2.7		<b>Product sensor, 25 pins</b> Labels are triggered to be applied as soon as a product has been detached, e.g. on a conveyor belt.
2.8		<b>I/O interface connector SUB-D, 25 pins</b> All control signals can be attached to the I/O interface using clamping screws.
2.9		<b>Warning light</b> In addition to the information indicated on the display of a printer, states are signalled. <b>Red</b> Collective error <b>Yellow</b> Pre-warning to a label web or a ribbon ending <b>Green</b> Device ready USB cable (1 m) to connect to HERMES Q Assembly materials are provided for vertical printer installation only. <b>1</b> Chassis assembly <b>2</b> Bracket assembly

2.10		<b>External operation panel</b> If the operation panel of a printer cannot be accessed, an additional external one can be plugged. Same functionality as on the printer Landscape or portrait mode Operability as desired on the external operation panel or on the printer
		Printer connectivity: USB 2.0 Hi-Speed device cab provides specified <b>connecting USB cables</b> for power supply. Lengths are 1.8 m to 16 m.
2.11		<b>Label selection - I/O box</b> A maximum of 16 different labels can be selected from a memory card by a master control unit, e.g. PLC.
2.12		<b>Hand switch TR2</b> to be attached to the I/O interface
2.13		<b>Foot switch</b> to be attached to the I/O interface
2.14		<b>Connecting RS232 C cable</b> 9/9 pins, 3 m
2.15		<b>Scanner CC200</b> provided on request

**Options** are parts or units to perform special functions. They are assembled to a printer in addition to or instead of standards.

If order implies options be assembled ex factory, the part numbers of such printers and options are added by .250. Options delivered separately are added by .001.

Pos.	Designation	roll Ø	205	305	HERMES Q2	HERMES Q4.3	HERMES Q4	HERMES Q6.3	.250	.001	.486	.488
3.1	Automatic ribbon saving		●	●	-	□	□	□	●	-	-	-
3.2	UHF RFID module RS		●	●	-	□	□	□	●	-	●	-
	UHF RFID module HS		●	●	-	□	□	□	●	-	-	●
3.3	Label unwinder K40		●	●	□	□	□	□	●	●	-	-
3.4/3.5	Adapters 40/50 and 76/100		●	●	□	□	□	□	●	●	-	-
3.6	Spacers		●	-	□	□	□	-	●	●	-	-
3.7	Margin stop 10		●	-	□	□	□	□	●	●	-	-
3.8	Cover		●	-	□	□	□	□	●	●	-	-
3.9	Print head pressure system, reduced force		●	●	□	□	-	□	●	●	-	-
3.10	Extended peel-off plate (+10 mm)		●	●	□	□	□	□	●	●	-	-
3.11	Print roller DRS		●	●	□	□	□	□	●	●	-	-
3.12	Antistatic brush		●	●	□	□	□	-	●	●	-	-
3.13	Draw roller ZS		●	●	□	□	□	□	●	●	-	-
3.14	Interface for plugging an external label sensor		●	●	□	□	□	□	●	●	-	-
3.15	2 port Ethernet switch 10/100 Mbit/s		●	●	□	□	□	□	●	●	-	-
3.16	Label sensor, modified		●	●	□	-	-	-	●	●	-	-



3.1

assembly  
ex factory only

### Automatic ribbon saving

Use is recommended in cases of at least 60 mm unprinted area on a label. While labels are fed, the print head is lifted and the ribbon stopped, resulting in less material consumption.



3.2

assembly to  
a printer ex factory  
excludes automatic  
ribbon saving

### UHF RFID module

Read/write antennas are assembled directly to a print head or a feeding unit. Using a 4214 applicator enables defective labels be ejected.



See information on [www.cab.de/en/rfid](http://www.cab.de/en/rfid)



3.3



3.4

### Adapter 40/50

to pick up label rolls having a core diameter of 50 mm and minimum widths of 20 mm. One adapter is sufficient if material width does not exceed 50 mm.



3.5



3.6

### Adapter 76/100

to pick up label rolls having a core diameter of 100 mm and minimum widths of 20 mm. One adapter is sufficient if material width does not exceed 50 mm.



3.7



3.16

### Spacers

to process narrow labels provided on liners  $\leq 20$  mm wide, wound on a roll or a reel.

Ribbon protruding on both sides prevents from wrinkling. The label guidance is therefore offset by 7 mm from the middle wall with spacers.

A modified label sensor is included on delivery.

Reel plate wall thickness 1 - 2 mm

### Label sensor, modified

Provided for labels requiring a sensor distant up to 26 mm to the locating edge. This sensor cannot be fixed with a screw.



3.7



### Margin stop 10

to guide narrow labels provided on a liner 10 - 24 mm wide, wound on a roll (no reels) having a core diameter of 76 mm.

Operate only with a spacer

# Options

3.8

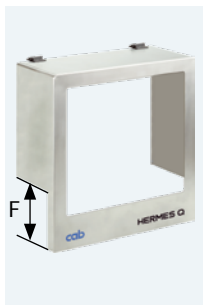

## Cover

to prevent from contamination and contact  
 Maximum outside diameter for label rolls is 205 mm  
 Assembly in vertical orientation, rotated by  $\pm 90^\circ$  or horizontally  
 Depth of a pad immersing Dim. F

	Dimension F mm		
	Standard	Optional	on request
HERMES Q2	60	100	up to 120
HERMES Q4/Q4.3	60	100	up to 120
HERMES Q6	25	-	up to 120

3.9



## Print head pressure system, reduced force

Thermal direct printing requires less pressure on a print head.  
 Reduced force results in a decrease of wear. Product life extends.

Thermal direct printing only

3.10



## Extended peel-off plate (+10 mm)

Recommended

- if labels are picked up by a robotic arm,
- if readable area is required for scanning,
- when installing an antistatic brush

3.11



## Print roller DRS

Silicone coating enables an extra long product life,  
 taken a higher print offset into account

3.12



## Antistatic brush

Electrostatic charge is reduced when plastic labels  
 are printed and peeled off.

Operate only with an extended peel-off plate.

3.13



## Draw roller ZS

Made of steel, to avoid tension on a liner tape:

- if label height exceeds 150 mm
- when peeling off without backfeed
- if thick liner materials are processed
- when applying labels using a demand module 5114/16

3.14



## Interface for plugging an external label sensor

M12 plug, 5 pins, a-coded  
 Plug-compatible with CEON and other sensors based on  
 PNP and 24 V

3.15



## 2 port Ethernet switch 10/100 Mbit/s

to connect another terminal device in a joint network.  
 Signals are looped through.

# Technical data

● typical ■ standard □ option

Label printer		type	HERMES Q2		HERMES Q4.3		HERMES Q4		HERMES Q6.3		
Printing method	Thermal transfer		●	●	●	●	●	●	●	●	
	Thermal direct		-	-	●	●	-	-	●	●	
Printable resolution	dpi		300	600	200	300	300	600	200	300	
Print speed	up to mm/s		300	150	300	300	300	150	250	250	
Print width	up to mm		56.9	54.1	104	108.4	105.7	105.7	168	162.6	
Print length	up to mm		12,000	3,000	13,500	6,000	6,000	1,500	9,000	4,000	
Direction to which dispense labels			L = to the left, R = to the right								
Print distance to the locating edge	mm		1	1	1	1	1	1	1	1	
incl. automatic ribbon saving L / R mm			-	-	2.2 / 1.6	0 / -0.7	1 / 1	1 / 1	0.2 / 0.2	2.9 / 2.9	
<b>UHF RFID</b>											
UHF RFID module			-	-	□	□	□	□	□	□	
<b>Materials</b>											
Labels			paper, PET, PE, PP, PI, PVC, PU, acrylate, Tyvec								
		on a roll	●		●		●		●		
		on a reel	●		-		-		-		
Labels <sup>1)</sup>	Width	mm	4 - 58		10 - 114		10 - 114		46 - 174		
	Height	from mm	3		4		4		6		
	Thickness	up to mm	0.60		0.60		0.60		0.60		
Liner tape	Width if operating a roll	mm	24 - 62		24 - 118		24 - 118		50 - 178		
	Width <sup>2)</sup> if operating a reel or a roll	mm	10 - 24		-		10 - 24		-		
	Thickness	mm	0.03 - 0.08		0.03 - 0.08		0.03 - 0.08		0.03 - 0.08		
Roll unwinder	Outside roll diameter	up to mm	205 / 305		205 / 305		205 / 305		205 / 305		
	reel diameter	up to mm	205		-		-		-		
	Core diameter	mm	76								
	Winding		outside or inside								
Roll rewinder	Outside diameter	up to mm	155 / 205								
	Core diameter	mm	76								
Ribbon <sup>3)</sup>	Ink side		outside or inside								
	Roll diameter	up to mm	90								
	Core diameter	mm	25.4								
	Length	up to m	600								
	Width	mm	25 - 67		25 - 114		25 - 114		50 - 170		
	Automatic ribbon saving		-		□		□		□		
<b>Printer dimensions and weights</b>											
Width	mm		207		260		260		320		
Height	roll diameters 205 / 305	mm	400 / 430								
Depth	roll diameters 205 / 305	mm	400 / 500								
Weight	roll diameters 205 / 305	approx. kg	15 / 16		16 / 17		16 / 17		20		
<b>Label sensor indicating positions</b>											
Transmissive sensor	detecting		labels, punch marks or print marks, as well as materials ending								
Reflective sensor	bottom reflex	detecting	print marks on non-transparent liners, as well as materials ending								
Sensor distance to the locating edge	standard	mm	2 - 12		2 - 60		2 - 60		2 - 60		
	modified	mm	2 - 26								
Material passage	mm		2								
<b>Electronics</b>											
32-bit processor	MHz		800								
RAM	MB		256								
IFFS memory	MB		50								
Slot to insert a memory card (SDHC, SDXC)			■								
Battery to display date and real time			■								
Data (e.g. serial numbering) preserved if power turns off			■								
<b>Interfaces</b>											
RS232C	1,200 to 230,400 baud / 8 bits		■								
USB 2.0 Hi-Speed to connect a PC			■								
Ethernet	10/100 Mbit/s		LPD, RawIP printing, SOAP web service, OPC UA, WebDAV DHCP, HTTP/HTTPS, FTP/FTPS, TIME, NTP, Zeroconf, SNMP, SMTP, VNC								
2 USB hosts on the control panel, 2 USB hosts on the back of a unit			Service key, USB stick, USB WLAN stick, USB WLAN stick including a rod antenna, keyboard, barcode scanner, warning light, external control panel								
USB host	24 VDC, to connect a peripheral device		■								
Digital I/O interface, 10 inputs / 11 outputs			■								
Interface for plugging an external label sensor			□								
2 port Ethernet switch	10/100 Mbit/s		□								

<sup>1)</sup> Limitations can occur when processing small labels, thin materials or materials using a strong adhesive. Critical applications need testing.

<sup>2)</sup> Spacers attached to the label unwinder and the unit rewinding the liner tape help feeding the ribbon centered above the labels.

<sup>3)</sup> The ribbon must correspond at least to the width of the liner tape.

# Technical data

■ standard □ option

Operating data	
Voltage	100-240 VAC, 50/60 Hz, PFC
Power consumption	standby <10 W / typical 100 W / max. 200 W
Temperature / Operation	+5 - 40°C / 10 - 85 %, not condensing
humidity	Stock 0 - 60°C / 20 - 85 %, not condensing
	Transport -25 - 60°C / 20 - 85 %, not condensing
Approvals	CE, FCC Class A, ICES-3, cULus, CB, RCM Mark, CCC, CoC Mexico, BSMI Mark, KC Mark
Operation panel	
Colored LCD touch display	Screen diagonal " 4,3 Resolution Width x Height px 480 x 272
Setup options	
Print Labels Ribbon Peel off Apply label Interfaces Error	Region: - Language - Country - Keyboard - Time zone Time Display: - Brightness - Power saving mode - Orientation Interpreter
Status bar	
	Data reception WLAN Record data stream Ethernet Pre-warning to a ribbon ending USB slave SD memory card plugged in Time USB memory stick plugged in
Monitoring	
	Ribbon Direction of winding Pinch roller open Pre-warning Peripheral error Material ending Labels Pre-warning Material ending Print head Voltage Temperature open
Test routines	
System diagnostics	on start-up, the print head is also detected
Information display, print test, analysis	Status printout Test grid List of fonts Label profile List of devices List of events WLAN status Monitor mode Record print data on a memory card
Status reports	- Printout of device settings, e.g. durations of printing and hours in operation - Device status request triggered by software command - Display of network errors, missing links, barcode errors, peripheral errors, etc.
Fonts	
Provided internally	5 bitmap fonts: 12 x 12 dots 16 x 16 dots 16 x 32 dots OCR-A OCR-B 7 vector fonts: AR Heiti Medium GB-Mono CG Triumvirate Condensed Bold Garuda HanWangHeiLight Monospace 821 Swiss 721 Regular, Bold
To be stored	TrueType fonts
Character sets	Windows-1250 to -1257 DOS 437, 737, 775, 850, 852, 857, 862, 864, 866, 869 EBCDIC 500 ISO 8859-1 to -10 and -13 to -16 WinOEM 720 UTF-8 MacRoman DEC MCS KOI8-R Western European Cyrillic Eastern European Greek Chinese, simplified Latin Chinese, traditional Hebrew Thai Arabic

Fonts	
Bitmap fonts	Widths and heights 1 - 3 mm Zoom factors 2 to 10 Orientations 0°, 90°, 180°, 270°
Vector / TrueType fonts	Widths and heights 0,9 - 128 mm Continuous zoom 360° orientation in steps of 1°
Font styles	bold, italic, underlined, outline, inverse - depending from the font type
Character spacing	variable or monospace for fixed spacing
Graphics	
Elements	lines, arrows, rectangles, circles, ellipses - filled or filled with fading
Formats	PCX, IMG, BMP, TIF, MAC, GIF, PNG
Codes	
1D barcodes (linear)	Code 39, Code 93 Interleaved 2/5 Code 39 Full ASCII Ident and routing code Code 128 A, B, C of Deutsche Post EAN 8, 13 Codabar EAN/UCC 128/GS1-128 JAN 8, 13 EAN/UPC Appendix 2 MSI EAN/UPC Appendix 5 Plessey FIM Postnet HIBC RSS 14 UPC A, E, E0
2D and stacked codes	DataMatrix DataMatrix Rectangle Extension QR code Micro QR code rMQR code GS1 QR code GS1 DataMatrix GS1 Digital Link (QR and DataMatrix) PDF 417 Micro PDF 417 UPS MaxiCode GS1 DataBar Aztec Codablock F Dotcode RSS 14 truncated, limited, stacked, stacked omni-directional Heights, modular widths and ratio are variable Orientations 0°, 90°, 180°, 270° Check digit, plain text printout and start/stop coding are options depending from the code type.
Software	
Label software	cablabel S3 Lite ■ cablabel S3 Viewer ■ cablabel S3 Pro □ cablabel S3 Print □
Running also with	CODESOFT Loftware Spectrum NiceLabel BarTender
Stand-alone operation	■
Windows printer drivers certified WHQL for	Windows 10 Server 2016 Windows 11 Server 2019 Server 2022 ■
Apple printer drivers	Mac OS X 10.6 or any later release ■
Linux printer drivers	CUPS 1.2 or any later release ■
Programming	JScript printer language ■ abc Basic Compiler ■ ZPL II (Datastream be tested in advance) □
Integration	SAP ■ Database Connector ■
Administration	Printer control ■ Configuration on the Intranet / Internet ■

cab uses free and Open Source software in its products.  
For information see [www.cab.de/opensource](http://www.cab.de/opensource)

# cablabel S3 software

## Design, print, administrate

cablabel S3 opens up the full potential of cab devices. Creating a label is the first step. cablabel S3 adapts to requirements easily using a modular design. Plug-ins like the JScript Viewer support native JScript programming, as well as other features. The designer user interface and the JScript code synchronize in real time. The Database Connector and other special features can be integrated, so are barcode verifiers.



For further information see  
[www.cab.de/en/cablabel](http://www.cab.de/en/cablabel)

## Stand-alone printing

A printer can select and print labels even when the system is disconnected from a host.

Labels are designed using software such as cablabel S3 or a text editor on a PC. Label formats, texts, graphics and data taken from a database are transferred to a memory card, a USB memory stick or the internal IFFS memory.

Only variable data are sent to the printer using a keyboard, a barcode scanner, scale or another host system and/or are recalled from a host by the Database Connector and printed.



## OPC UA

The latest cab printers are ready to interact with machines and components of different manufacturers in industrial plants.

An OPC UA server and a client are part of the firmware.

The server enables a printer be configured and controlled. Dynamic print data can be edited using a defined programming interface.

The integral client enables reading data fields from other machines ready for OPC UA, as well as transferring data to a label. No additional software is needed.



# Printer control

## Drivers



cab provides drivers to control a printer with software other than cablabel S3.



Free download on [www.cab.de/en/support](http://www.cab.de/en/support)



## Programming



### JScript

cab printers embed JScript language. Download free manual on [www.cab.de/en/programming](http://www.cab.de/en/programming)



### abc Basic Compiler

Integral to the firmware, abc in addition to JScript enables advanced programming before data are edited for printout. For example, external printer languages can be replaced without intervening in a print job in progress. Data may be imported as well from other systems such as scales, barcode scanners or PLC.

## Connecting to SAP®

Labels can be printed from SAP<sup>1)</sup> on cab devices and systems. There are various methods:

- Printing with SAPscript
- Printing with SmartForms
- Printing with Adobe Interactive Forms

See instructions in detail on [www.cab.de/en/sap](http://www.cab.de/en/sap)

<sup>1)</sup> SAP and associated logos are trademarks or registered trademarks of SAP SE.

# Printer administration



## Configuration on the Intranet / Internet

Integral HTTP / FTP servers enable a printer be controlled or configured, firmware be updated and memory cards be administrated using standard applications such as a web browser or a FTP client.

Administrators and operators on behalf of SNMP / SMTP are notified of states, alerts and errors by email or SNMP datagrams. Time and date are synchronized by a time server.

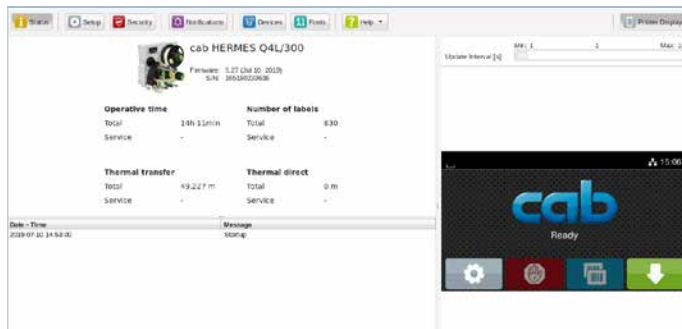

## Database Connector

Printers in a network may access data from a ODBC / OLEDB database and print it on labels. Data can be rewritten to a database while print jobs are in progress.



# Applicators



## Automatic labeling

The HERMES HQ applicators are a further development of the proven HERMES applicators, fully compatible, adding extra functions. Existing applications can continue without limitations.

## Easy to configure

The applicator can be fully set on the printer control panel, configurations be stored and called up. Automatic calibration features speed up the setup.

## Process control

Detailed statistical values are provided, so are sophisticated error messages. Constant control enables response right away in events of errors.

## Updates

Applicator firmware can be updated on the printer control panel or the printer's web server. New features and specific solutions can therefore be tested right away and distributed in the field.

### 1 Long product life

by a precise and low-wear linear guide

### 2 Products of variable heights

Labels can be applied on different heights using a stroke cylinder. Its standard lengths are 200, 300 and 400 mm. Further lengths can be provided on request.

### 3 Protective chassis

is a standard to protect the cylinder and the guide. It can be provided adapted to the product jig on a labeling workstation.

### 4 Highly reliable processes

Support air and intake air can be defined, so can stroke speed. Sensor control

### 5 Label application

in real time. Small or large labels, 4 to 250 mm high and 4 to 174 mm wide, can be processed using an applicator

### 6 Pivoting applicator

The print mechanics can be accessed quickly and easily in case of maintenance or if materials have to be replaced.



## Options:

### Pressure-reducing valve

It reduces the pressure exerted by the stroke cylinder to a product.

### Pressure-reduced applicator

It has been designed for manual workstations missing a protective cover. The cylinder diameter is reduced to 12 mm. To prevent from injuries, a safety valve limits compressed air to a maximum of 4.8 bar.

# Applicators, transfer modules and options

## Overview

		HERMES Q			Vacuum pad, spring-mounted	Universal pad	Tamp-on pad	Tamp-on pad, providing a damping layer	Tamp-on pad, providing a label stop	Blow-on pad	Form pad	Universal pad, spring-mounted	Tamp-on pad, spring-mounted	Roll-on pad	Corner-wrap pad	Brush	Transportation belt	Vacuum pad	Pressure-reducing valve	Pressure-reduced applicator			
Applicators	Page	2	4	6.3	Transfer modules														Options				
		Order code			10	11	11	12	61	21	88	31	31	41	51			90	.212	.220			
Product marking	Swing applicator	18	HQ 3214	HQ 3214			<input type="checkbox"/>	<input type="checkbox"/>	<input type="checkbox"/>	<input type="checkbox"/>													
	Stroke applicator	19/20	HQ 4114	HQ 4114			<input type="checkbox"/>	<input type="checkbox"/>	<input type="checkbox"/>	<input type="checkbox"/>	<input type="checkbox"/>									<input type="checkbox"/>	<input type="checkbox"/>		
		19/20			HQ 4116			<input type="checkbox"/>	<input type="checkbox"/>	<input type="checkbox"/>	<input type="checkbox"/>										<input type="checkbox"/>		
	Stroke turn applicator	21	HQ 4214	HQ 4214			<input type="checkbox"/>	<input type="checkbox"/>	<input type="checkbox"/>	<input type="checkbox"/>											<input type="checkbox"/>	<input type="checkbox"/>	
	Stroke applicator	22	HQ 4414	HQ 4414			<input type="checkbox"/>	<input type="checkbox"/>	<input type="checkbox"/>												<input type="checkbox"/>	<input type="checkbox"/>	
	Swing stroke applicator	23	HQ 4514	HQ 4514						<input type="checkbox"/>													
Package marking	Front side applicator	25	HQ 3014				<input type="checkbox"/>			<input type="checkbox"/>			<input type="checkbox"/>										
		25		HQ 3016				<input type="checkbox"/>					<input type="checkbox"/>										
	Stroke applicator	26/27	HQ 4014			<input type="checkbox"/>	<input type="checkbox"/>			<input type="checkbox"/>		<input type="checkbox"/>	<input type="checkbox"/>	<input type="checkbox"/>	<input type="checkbox"/>						<input type="checkbox"/>	<input type="checkbox"/>	
		26/27		HQ 4016			<input type="checkbox"/>					<input type="checkbox"/>	<input type="checkbox"/>								<input type="checkbox"/>		
	Stroke applicator	28	HQ 4024		<input type="checkbox"/>																	<input type="checkbox"/>	
	Stroke blow applicator	29	HQ 4614						<input type="checkbox"/>														
	Demand module	30	HQ 5112	HQ 5114	HQ 5116											<input type="checkbox"/>							
	Vacuum belt applicator	31	HQ 5314	HQ 5316														<input type="checkbox"/>					
		32	HQ 5414	HQ 5416														<input type="checkbox"/>					
	Demand table	33	HQ 5714														<input type="checkbox"/>						
Air jet box	34	HQ 6114															<input type="checkbox"/>						

### Applicator type code index HQ 4414L-200

Type	HERMES Q	2	4	4.3	6.3
Label printer	HERMES Q2	<input type="checkbox"/>	<input type="checkbox"/>	<input type="checkbox"/>	<input type="checkbox"/>
	HERMES Q4	<input type="checkbox"/>	<input type="checkbox"/>	<input type="checkbox"/>	<input type="checkbox"/>
	HERMES Q4.3	<input type="checkbox"/>	<input type="checkbox"/>	<input type="checkbox"/>	<input type="checkbox"/>
	HERMES Q6.3	<input type="checkbox"/>	<input type="checkbox"/>	<input type="checkbox"/>	<input type="checkbox"/>
Direction to which dispense labels	left	<input type="checkbox"/>	<input type="checkbox"/>	<input type="checkbox"/>	<input type="checkbox"/>
	right	<input type="checkbox"/>	<input type="checkbox"/>	<input type="checkbox"/>	<input type="checkbox"/>
Cylinder stroke		<input type="checkbox"/>	<input type="checkbox"/>	<input type="checkbox"/>	<input type="checkbox"/>
		<input type="checkbox"/>	<input type="checkbox"/>	<input type="checkbox"/>	<input type="checkbox"/>
		<input type="checkbox"/>	<input type="checkbox"/>	<input type="checkbox"/>	<input type="checkbox"/>
		<input type="checkbox"/>	<input type="checkbox"/>	<input type="checkbox"/>	<input type="checkbox"/>
		<input type="checkbox"/>	<input type="checkbox"/>	<input type="checkbox"/>	<input type="checkbox"/>
		<input type="checkbox"/>	<input type="checkbox"/>	<input type="checkbox"/>	<input type="checkbox"/>

auf Anfrage

### Transfer module type code index 4014R-1100

Applicator (see applicator type codes)	4014R	11	12	61	21	88	31	41	51	90
Type Vacuum pad, spring-mounted	<input type="checkbox"/>	<input type="checkbox"/>	<input type="checkbox"/>	<input type="checkbox"/>	<input type="checkbox"/>	<input type="checkbox"/>	<input type="checkbox"/>	<input type="checkbox"/>	<input type="checkbox"/>	<input type="checkbox"/>
Universal / tamp-on pad, providing sliding foil	<input type="checkbox"/>	<input type="checkbox"/>	<input type="checkbox"/>	<input type="checkbox"/>	<input type="checkbox"/>	<input type="checkbox"/>	<input type="checkbox"/>	<input type="checkbox"/>	<input type="checkbox"/>	<input type="checkbox"/>
Tamp-on pad, providing a damping layer	<input type="checkbox"/>	<input type="checkbox"/>	<input type="checkbox"/>	<input type="checkbox"/>	<input type="checkbox"/>	<input type="checkbox"/>	<input type="checkbox"/>	<input type="checkbox"/>	<input type="checkbox"/>	<input type="checkbox"/>
Tamp-on pad, providing a label stop	<input type="checkbox"/>	<input type="checkbox"/>	<input type="checkbox"/>	<input type="checkbox"/>	<input type="checkbox"/>	<input type="checkbox"/>	<input type="checkbox"/>	<input type="checkbox"/>	<input type="checkbox"/>	<input type="checkbox"/>
Blow-on pad	<input type="checkbox"/>	<input type="checkbox"/>	<input type="checkbox"/>	<input type="checkbox"/>	<input type="checkbox"/>	<input type="checkbox"/>	<input type="checkbox"/>	<input type="checkbox"/>	<input type="checkbox"/>	<input type="checkbox"/>
Form pad	<input type="checkbox"/>	<input type="checkbox"/>	<input type="checkbox"/>	<input type="checkbox"/>	<input type="checkbox"/>	<input type="checkbox"/>	<input type="checkbox"/>	<input type="checkbox"/>	<input type="checkbox"/>	<input type="checkbox"/>
Universal / tamp-on pad, spring-mounted	<input type="checkbox"/>	<input type="checkbox"/>	<input type="checkbox"/>	<input type="checkbox"/>	<input type="checkbox"/>	<input type="checkbox"/>	<input type="checkbox"/>	<input type="checkbox"/>	<input type="checkbox"/>	<input type="checkbox"/>
Roll-on pad	<input type="checkbox"/>	<input type="checkbox"/>	<input type="checkbox"/>	<input type="checkbox"/>	<input type="checkbox"/>	<input type="checkbox"/>	<input type="checkbox"/>	<input type="checkbox"/>	<input type="checkbox"/>	<input type="checkbox"/>
Corner-wrap pad	<input type="checkbox"/>	<input type="checkbox"/>	<input type="checkbox"/>	<input type="checkbox"/>	<input type="checkbox"/>	<input type="checkbox"/>	<input type="checkbox"/>	<input type="checkbox"/>	<input type="checkbox"/>	<input type="checkbox"/>
Vacuum pad	<input type="checkbox"/>	<input type="checkbox"/>	<input type="checkbox"/>	<input type="checkbox"/>	<input type="checkbox"/>	<input type="checkbox"/>	<input type="checkbox"/>	<input type="checkbox"/>	<input type="checkbox"/>	<input type="checkbox"/>
<input type="checkbox"/> Depth of a pad immersing in mm	<input type="checkbox"/>	<input type="checkbox"/>	<input type="checkbox"/>	<input type="checkbox"/>	<input type="checkbox"/>	<input type="checkbox"/>	<input type="checkbox"/>	<input type="checkbox"/>	<input type="checkbox"/>	<input type="checkbox"/>

A pad dips into a surface in the range of a label. See specified depths of immersion in the technical data of an applicator.

# Swing applicator HQ 3214

Labels very small or midsized can be applied in real time, preferably from the side.

The pad locates in front of the peel-off plate. It picks up a label while it is being printed. A rotary cylinder pivots into position. The label is transferred to a product by a stroke cylinder. Rotary angles and linear hubs are adjustable.



## Accessories

5.13 **Blow tube**

5.14 **Unit to regulate compressed air**

4.1



Swing applicator		HQ 3214 L/R-40
Label application		from the side
State of a product	at rest	■
at the moment a label is applied	in motion	only blow-on pad
Product heights	uniform	■
Distance of a product to the peel-off plate	mm	250-280
Linear guidance, horizontal	mm	5-30
Pivot angles		45° - 95°
Weight of applicator	packaging excluded kg	4.5
Consumption of power	W max.	15
Compressed air	bar	4.5
Cycle rate <sup>1)</sup>	labels/min approx.	20

<sup>1)</sup>calculated using labels 40 mm high and a print speed of 100 mm/s



### Tamp-on pad

Labels are precisely tamped on plane surfaces. Recessed levels are possible as well.



### Tamp-on pad, providing a damping layer

When applying labels to hard surfaces, the noise level is reduced. It benefits also in cases of rough structures or little unevenness.

### Tamp-on pad, providing a label stop

It enables small labels be applied exactly on spot to a product.



### Blow-on pad

It benefits when labels have to be applied to sensitive surfaces or products in motion. Labels are blown on by a blast of air. Stroke cylinder adjustment enables bridging distances of 5 to 10 mm to the surface of a product.

			Tamp-on pad	Tamp-on pad, providing a damping layer	Tamp-on pad, providing a label stop	Blow-on pad
Transfer modules			3214 L/R 11 F	3214 L/R 12 F	3214 L/R 61 F	3214 L/R 2100
Label widths	HERMES Q2	mm	4-58	10-58	10-58	10-58
	HERMES Q4/Q4.3	mm	10-114	10-114	10-114	10-80
Label heights	HERMES Q2	mm	5-80	8-80	5-80	10-80
	HERMES Q4/Q4.3	mm	8-80	8-80	8-80	10-80
Depth of a pad immersing F		up to mm	30	30	30	-

# Stroke applicators HQ 4114, HQ 4116

Labels very small or midsized can be applied in real time from all sides.

The pad locates in front of the peel-off plate. It picks up a label while it is being printed. Powered by a short stroke cylinder, the pad is brought into position in horizontal direction. The label is transferred to a product by a stroke cylinder. The length of the stroke cylinder defines the maximum distance of a product to the peel-off plate.



## Accessories

5.13 **Blow tube**

5.14 **Unit to regulate compressed air**

## Options

5.17 **Pressure-reducing valve**

5.18 **Pressure-reduced applicator**

4.2



Stroke applicators	HQ 4114 L/R-200	HQ 4114 L/R-300	HQ 4114 L/R-400	HQ 4114 L/R-600	HQ 4116 L/R-200	HQ 4116 L/R-300	HQ 4116 L/R-400
Label applications	from the top, from below, from the side						
State of a product	at rest ■						
at the moment a label is applied	in motion						
Product heights	uniform						
	variable						
Short stroke cylinder, horizontal	mm						
	10						
Distance of a product to the bottom of the unit	up to mm						
	135	235	335	535	135	235	335
Weight of applicator	packaging excluded kg						
	5	6	7	9	5	6	7,5
Consumption of power	W max.						
	15						
Compressed air	bar						
	4.5						
Cycle rate <sup>1)</sup>	labels/min approx.						
	30						

<sup>1)</sup> Calculated using a stroke of 100 mm below the unit, labels 40 mm high, a print speed of 100 mm/s



### Tamp-on pad

Labels are precisely tamped on plane surfaces. Recessed levels are possible as well.

### Tamp-on pad, providing a damping layer

When applying labels to hard surfaces, the noise level is reduced. It benefits also in cases of rough structures or little unevenness.

### Tamp-on pad, providing a label stop

It enables small labels be applied exactly on spot to a product.

### Blow-on pad

It benefits when labels have to be applied to sensitive surfaces or products in motion. Labels are blown on by a blast of air. Stroke cylinder adjustment enables bridging distances of 5 to 10 mm to the surface of a product.

			Tamp-on pad	Tamp-on pad, providing a damping layer	Tamp-on pad, providing a label stop	Blow-on pad
Transfer modules			4114, 4116 L/R 11 F	4114, 4116 L/R 12 F	4114, 4116 L/R 61 F	4114 L/R 2100
Label widths	HERMES Q2	mm	4-58	10-58	10-58	10-58
	HERMES Q4/Q4.3	mm	10-114	10-114	10-114	10-114
	HERMES Q6.3	mm	50-174	50-174	50-174	-
Label heights	HERMES Q2	mm	4-80	8-80	4-80	10-80
	HERMES Q4/Q4.3	mm	8-80	8-80	8-80	10-80
	HERMES Q6.3	mm	8-80	8-80	8-80	-
Depth of a pad immersing <sup>F2)</sup>	up to mm	130	130	130	-	

<sup>2)</sup> On the cover HERMES Q2/Q4/Q4.3 cut-out dimension F standard 60 mm, optional 100 mm, on request up to 110 mm  
On the cover HERMES Q6.3 cut-out dimension F standard 25 mm, on request up to 110 mm

# Stroke applicators HQ 4114, HQ 4116

Labels very small or midsized can be applied in real time from all sides.

The pad locates in front of the peel-off plate. It picks up a label while it is being printed. Powered by a short stroke cylinder, the pad is brought into position in horizontal direction. The label is transferred to a product by a stroke cylinder. The length of the stroke cylinder defines the maximum distance of a product to the peel-off plate.



## Accessories

5.13 **Blow tube**

5.14 **Unit to regulate compressed air**



Stroke applicators	HQ 4114 L/R-200	HQ 4114 L/R-300	HQ 4114 L/R-400	HQ 4114 L/R-600	HQ 4116 L/R-200	HQ 4116 L/R-300	HQ 4116 L/R-400
State of a product at the moment a label is applied	at rest						
Label applications	from the top, from below, from the side						
Product heights	variable						
Short stroke cylinder, horizontal	mm						
Distance of a product to the bottom of the unit	up to mm						
Weight of applicator packaging excluded	5	5.5	7	9	5.5	6	7.5
Consumption of power	W max.						
Compressed air	bar						
Cycle rate <sup>1)</sup>	labels/min approx.						

<sup>1)</sup> Calculated using a stroke of 100 mm below the unit, labels 40 mm high, a print speed of 100 mm/s  
If the height of the form pad exceeds 60 mm, the cover of HERMES Q must be adapted.

## Form pad

Labels are precisely applied to cylindric objects, inclined or curved surfaces. Curved form pads prevent from blistering on very smooth and plane surfaces. 200° maximum label wrapping on cylindric objects



Transfer module			Form pad 4114, 4116 L/R 8800
Label widths	HERMES Q2	mm	10 - 58
	HERMES Q4/Q4.3	mm	10 - 114
	HERMES Q6.3	mm	50 - 174
Label heights		mm	8 - 80

# Stroke turn applicator HQ 4214

Labels very small or midsized can be applied in real time from all sides whenever the unit is difficult to install.

The pad locates in front of the peel-off plate. It picks up a label while it is being printed. Powered by a rotary cylinder, the pad pivots into position by at most 180° in horizontal direction. The label is transferred to a product by a stroke cylinder. The length of the stroke cylinder defines the maximum distance of a product to the peel-off plate.



## Accessories

- 5.13 **Blow tube**
- 5.14 **Unit to regulate compressed air**

## Options

- 5.17 **Pressure-reducing valve**
- 5.18 **Pressure-reduced applicator**



Stroke turn applicator		HQ 4214 L/R-200	HQ 4214 L/R-300	HQ 4214 L/R-400
State of a product	at rest		■	
	in motion		only blow-on pad	
Label applications			from the top, from below, from the side	
Product heights	uniform		only blow-on pad	
	variable		all tamp-on pads	
Rotary angle, horizontal	90°, 0° 180° if labels are no more than 15 mm high		■	
Distance of a product to the bottom of the unit	up to mm	135	235	335
Weight of applicator	packaging excluded kg	5	5.5	7.5
Consumption of power	W max.		15	
Compressed air	bar		4.5	
Cycle rate <sup>1)</sup>	labels/min approx.		20	

<sup>1)</sup> calculated using a stroke of 100 mm below the unit, labels 40 mm high, a print speed of 100 mm/s



### Tamp-on pad

Labels are precisely tamped on plane surfaces. Recessed levels are possible as well.

### Tamp-on pad, providing a damping layer

When applying labels to hard surfaces, the noise level is reduced. It benefits also in cases of rough structures or little unevenness.

### Tamp-on pad, providing a label stop

It enables small labels be applied exactly on spot to a product.

### Blow-on pad

It benefits when labels have to be applied to sensitive surfaces or products in motion. Labels are blown on by a blast of air. Stroke cylinder adjustment enables bridging distances of 5 to 10 mm to the surface of a product.

			Tamp-on pad	Tamp-on pad, providing a damping layer	Tamp-on pad, providing a label stop	Blow-on pad
Transfer modules			4214 L/R 11 F	4214 L/R 12 F	4214 L/R 61 F	4214 L/R 2100
Label widths	HERMES Q2	mm	4 - 58	10 - 58	10 - 58	10 - 58
	HERMES Q4/Q4.3	mm			10 - 80	
Label heights	HERMES Q2	mm	4 - 40	8 - 40	4 - 40	10 - 40
	HERMES Q4/Q4.3	mm	8 - 40	8 - 40	8 - 40	10 - 40
Depth of a pad immersing F <sup>1)</sup>	up to mm		90	90	90	-

<sup>2)</sup> On the cover HERMES Q2/Q4/Q4.3 cut-out dimension F standard 60 mm, optional 100 mm

# Stroke applicator HQ 4414

Labels very small or mid-sized can be applied in real time from all sides. Positions to which labels shall be applied can be adjusted in directions x and y.

The pad locates in front of the peel-off plate. It picks up a label while it is being printed. Powered by two short stroke cylinders, the pad is brought into position. The label is transferred to a product by a stroke cylinder. The length of the stroke cylinder defines the maximum distance of a product to the peel-off plate.



4.4



## Accessories

- 5.13 **Blow tube**
- 5.14 **Unit to regulate compressed air**

## Options

- 5.17 **Pressure-reducing valve**
- 5.18 **Pressure-reduced applicator**

Stroke applicators	HQ 4414 L/R-200	HQ 4414 L/R-300	HQ 4414 L/R-400	
State of a product at the moment a label is applied	at rest	■		
Label applications	from the top, from below, from the side			
Product heights	variable	■		
Short stroke cylinders, horizontal	direction x mm	3 - 7		
	direction y mm	11 - 15		
Distance of a product to the bottom of the unit	up to mm	135	235	335
Weight of applicator	packaging excluded kg	5	5.5	6
Consumption of power	W max.	15		
Compressed air	bar	4.5		
Cycle rate <sup>1)</sup>	labels/min approx.	25		

<sup>1)</sup> calculated using a stroke of 100 mm below the unit, labels 40 mm high, a print speed of 100 mm/s



### Tamp-on pad

Labels are precisely tamped on plane surfaces. Recessed levels are possible as well.



### Tamp-on pad, providing a damping layer

When applying labels to hard surfaces, the noise level is reduced. It benefits also in cases of rough structures or little unevenness.



### Tamp-on pad, providing a label stop

It enables small labels be applied exactly on spot to a product.

			Tamp-on pad	Tamp-on pad, providing a damping layer	Tamp-on pad, providing a label stop
Transfer modules			4414 L/R 11 F	4414 L/R 12 F	4414 L/R 61 F
Label widths	HERMES Q2	mm	4 - 58	10 - 58	10 - 58
	HERMES Q4/Q4.3	mm		10 - 114	
Label heights	HERMES Q2	mm	4 - 80	8 - 80	4 - 80
	HERMES Q4/Q4.3	mm		8 - 80	
Depth of a pad immersing F <sup>2)</sup>		up to mm		120	

<sup>2)</sup> On the cover HERMES Q2/Q4/Q4.3 cut-out dimension F standard 60 mm, optional 100 mm

# Swing stroke applicator HQ 4514

Labels can be applied in real time from all sides on inner surfaces of profiles and pipes. Stroke cylinder adjustment enables labels be transferred exactly to their dedicated spots.

The pad locates in front of the peel-off plate. It picks up a label while it is being printed. Powered by a rotary cylinder, the pad pivots to the level on which the label shall be applied. The label is moved to the point of transfer by a stroke cylinder.



## Accessories

### 5.13 Blow tube

### 5.14 Unit to regulate compressed air

4.5



Swing stroke applicators	HQ 4514 L/R-200	HQ 4514 L/R-300	HQ 4514 L/R-400
State of a product at the moment a label is applied	at rest	■	
Label applications	from the top, from below, from the side		
Product heights	uniform	■	
Pivot angle, vertical	120°		
Distance between the bottom of the unit and the upper label ending	up to mm 150 <sup>2)</sup>	250 <sup>2)</sup>	350 <sup>2)</sup>
Weight of applicator	packaging excluded kg 6	6.5	7
Consumption of power	W max.	15	
Compressed air	bar	4.5	
Cycle rate <sup>1)</sup>	labels/min approx.	20	

<sup>1)</sup> calculated using a stroke of 100 mm below the unit, labels 40 mm high, a print speed of 100 mm/s

<sup>2)</sup> depending from the height of a label



### Blow-on pad

Labels are blown on a product surface by a blast of air, bridging a distance of 5 to 10 mm.

Transfer module	Blow-on pad 4514 L/R 2100		
Label widths	HERMES Q2	mm	10 - 58
	HERMES Q4/Q4.3	mm	10 - 80
Label heights		mm	10 - 60

# Flag applicator HQ 4712

Labels can be applied in real time from all sides precisely on round materials such as cables, hoses or pipes.

The pad locates in front of the peel-off plate. It picks up a label while it is being printed. The label is transferred to the spot of application by a stroke cylinder. A further cylinder guides the material all around the material using cam control. First, both endings of a label are stuck together. Then the label is tamped to the round material. The length of the stroke cylinder defines the maximum distance of a product to the peel-off plate.

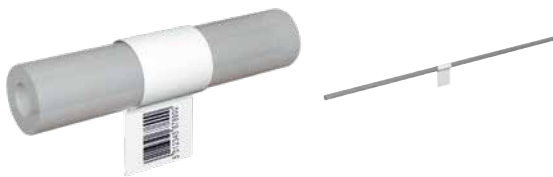

## Accessories

5.13 **Blow tube**

5.14 **Unit to regulate compressed air**

Flag applicator		HQ 4712
State of a product at the moment a label is applied	at rest	■
Label applications		from the top, from below, from the side rotated vertically: 0 - 180° clockwise (request in case of other rotations)
Product heights	uniform	■
Distance of a product to the bottom of the unit using a cylinder stroke of 300	at least mm up to mm	70 260
Depth of pliers immersing	mm	55
Offset P	up to mm	1.0 <sup>2)</sup>
Weight of applicator	packaging excluded kg	8
Consumption of power	W max.	15
Compressed air	bar	4.5
Cycle rate, printing and applying only <sup>3)</sup>	labels/min approx.	15

<sup>1)</sup> Processing labels 50 to 58 mm wide requires a spacer.

<sup>2)</sup> depending from the quality of a label

<sup>3)</sup> calculated using a print speed of 100 mm/s

<sup>4)</sup> Flag on product requires >60 mm clearance on one side without components, bend or step

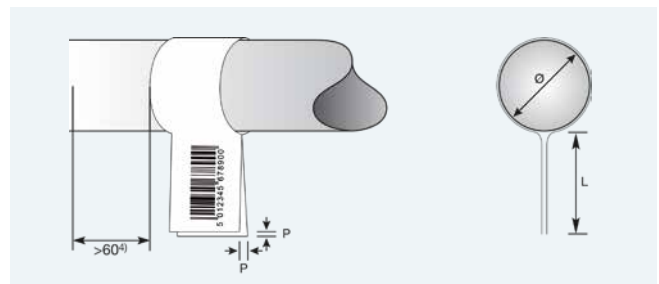
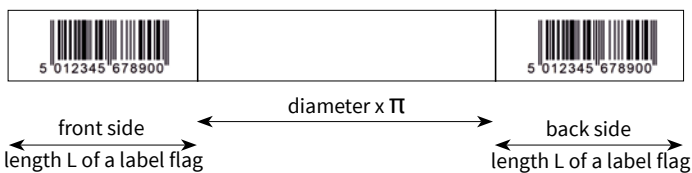

Transfer module		Form pad	
		4712 L 300	
Label widths	HERMES Q4L/Q4.3L	mm	50 <sup>1)</sup> - 100
Label heights		mm	10 - 50
Diameter		mm	3 - 16

# Front side applicators HQ 3014, HQ 3016

Labels can be applied in real time from the top or the side to packages in motion. Front sides or back sides of a package are preferred.

The pad locates in front of the peel-off plate. It picks up a label while it is being printed. The label is transferred to a product with the help of a rotary cylinder. The package is detected by a sensor and the pivot arm with the pad returned to its initial position.

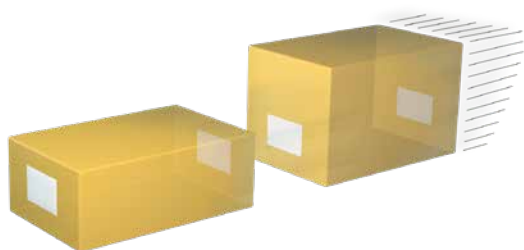

## Accessories

5.13 **Blow tube**

5.14 **Unit to regulate compressed air**

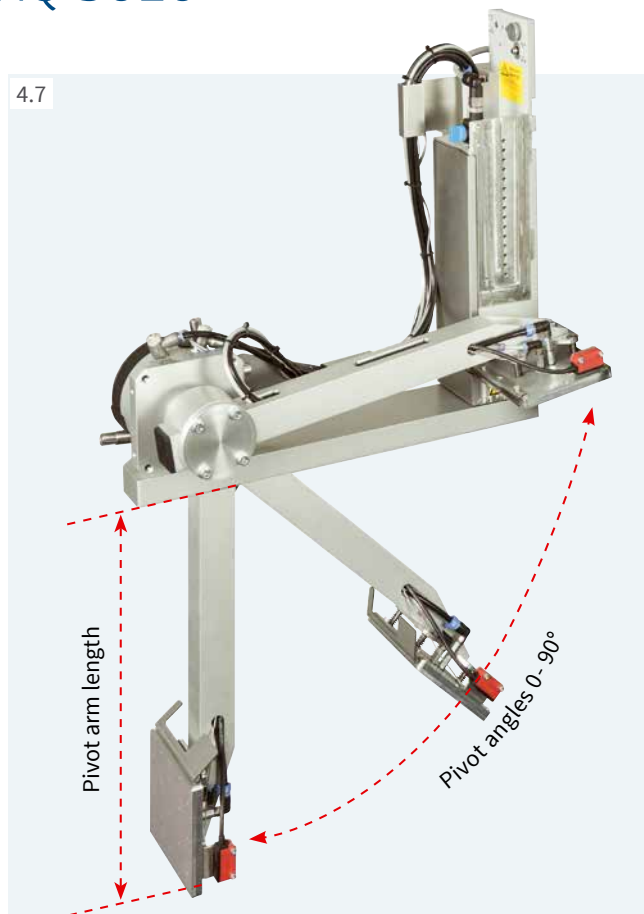

Front side applicators		HQ 3014 L/R-200	HQ 3014 L/R-300	HQ 3014 L/R-400	HQ 3014 L/R-600	HQ 3016 L/R-200	HQ 3016 L/R-300	HQ 3016 L/R-400	HQ 3016 L/R-600
State of a package	at rest				■				
	at the moment a label is applied					■			
Label applications	in motion	from the top, from the side, from the front, from the back							
Package heights	variable	■							
Pivot arm lengths <sup>1)</sup>	mm	200	300	400	600	200	300	400	600
Pivot angles		0 - 90°							
Weight of applicators	packaging excluded kg	9	9.5	10.5	11.5	9.5	10	11	12
Consumption of power	W max.	15							
Compressed air	bar	4,5							
Cycle rate <sup>2)</sup>	labels/min approx.	15							

<sup>1)</sup> Pivot arm length defines the spot of a label (lower margin) to be reached at 90° below a HERMES Q footprint.

<sup>2)</sup> calculated using a pivot arm 200 mm long, labels 100 mm high, a print speed of 100 mm/s



### Tamp-on pad

Labels are precisely tamped on plane surfaces. Recessed levels are possible as well.



### Tamp-on pad, spring-mounted

Labels can be applied to surfaces inclined by a maximum of 15°. Heights within the area of a label may vary by 10 mm at most.



### Blow-on pad

Labels are blown on a package surface by a blast of air, bridging a distance of 5 to 10 mm.

Transfer modules			Tamp-on pad 3014, 3016 L/R 1100	Tamp-on pad, spring-mounted 3014, 3016 L/R 3100	Blow-on pad 3014 L/R 2100
Label widths	HERMES Q4/Q4.3	mm	25 - 114	80 - 114	25 - 114
	HERMES Q6.3	mm	25 - 174	80 - 174	-
Label heights	HERMES Q4/Q4.3	mm	8 - 250	80 - 250	10 - 100
	HERMES Q6.3	mm	25 - 250	80 - 250	25 - 100

# Stroke applicators HQ 4014, HQ 4016

Labels can be applied in real time from all sides to packages. The type of pad defines whether a package has to be at rest or can be in motion at the time a label is applied.

The pad locates in front of the peel-off plate. It picks up a label while it is being printed. The label is transferred to a package with the help of a stroke cylinder. The package is detected by a sensor and the pad returned to its initial position. The length of the stroke cylinder defines the maximum distance of a package to the peel-off plate.



## Accessories

5.13 **Blow tube**

5.14 **Unit to regulate compressed air**

## Options

5.17 **Pressure-reducing valve**

5.18 **Reduced-force applicator**

4.8



Stroke applicators		HQ 4014L/R-200	HQ 4014L/R-300	HQ 4014L/R-400	HQ 4014L/R-600	HQ 4016L/R-200	HQ 4016L/R-300	HQ 4016L/R-400	HQ 4016L/R-600
Package heights	variable	■							
State of a package at the moment a label is applied	at rest	■							
Label applications		from the top, from below, from the side			from the top, from below	from the top, from below, from the side			from the top, from below
Distance of a package to the bottom of the unit	up to mm	130	230	330	530	130	230	330	530
Weight of applicator	packaging excluded kg	5	5	7	9	5	5.5	7.5	9.5
Consumption of power	W max.	15							
Compressed air	bar	4,5							
Cycle rate <sup>1)</sup>	labels/min approx.	25							

<sup>1)</sup> calculated using a stroke of 100 mm below the unit, labels 100 mm high, a print speed of 100 mm/s



### Tamp-on pad

Labels are precisely tamped on plane surfaces. Recessed levels are possible as well.

### Universal pad

Labels can be tamped on plane surfaces. Drilled holes are provided in gaps of 5 mm to suck a label. The holes are covered by a sliding foil, but can be opened according to the size of a label using a punching tool. Delivery includes two extra foils.

### Tamp-on pad, spring-mounted

Labels can be applied to surfaces inclined by a maximum of 15°. Heights within the area of a label may vary by 10 mm at most.

### Universal pad, spring-mounted

Labels can be applied to surfaces inclined by a maximum of 15°. Heights in the area of a label may vary by 10 mm at most. To suck a label, drilled holes are provided in gaps of 5 mm and covered by a sliding foil. Delivery includes two extra foils.

			Tamp-on pad	Universal pad	Tamp-on pad, spring-mounted	Universal pad, spring-mounted
Transfer modules			4014, 4016 L/R 11 F	4014 L/R 1100	4014, 4016 L/R 3100	4014 L/R 3100
Label widths	HERMES Q4/Q4.3	mm	20 - 114	75 / 90	80 - 114	116 / 116
	HERMES Q6.3	mm	50 - 174	-	80 - 174	-
Label heights	HERMES Q4/Q4.3	mm	20 - 210	60 / 90	80 - 210	102 / 152
	HERMES Q6.3	mm	25 - 210	-	80 - 210	-
Depth of a pad immersing F <sup>2)</sup>		up to mm	140	-	-	-

<sup>2)</sup> On the cover HERMES Q2/Q4/Q4.3 cut-out dimension F standard 60 mm, optional 100 mm, on request up to 120 mm  
On the cover HERMES Q6.3 cut-out dimension F standard 25 mm, on request up to 120 mm

# Stroke applicators HQ 4014, HQ 4016

Labels can be applied in real time from all sides to packages. The type of pad defines whether a package has to be at rest or can be in motion at the time a label is applied.

The pad locates in front of the peel-off plate. It picks up a label while it is being printed. The label is transferred to a package with the help of a stroke cylinder. The package is detected by a sensor and the pad returned to its initial position. The length of the stroke cylinder defines the maximum distance of a package to the peel-off plate.

## Accessories

### 5.13 Blow tube

### 5.14 Unit to regulate compressed air

## Options

### 5.17 Pressure-reducing valve

### 5.18 Pressure-reduced applicator

4.8



Stroke applicators		HQ 4014L/R-200	HQ 4014L/R-300	HQ 4014L/R-400	HQ 4014L/R-600	HQ 4016L/R-200	HQ 4016L/R-300	HQ 4016L/R-400	HQ 4016L/R-600
State of a package at the moment a label is applied	at rest	Blow-on pad, Corner-wrap pad							
	in motion	Blow-on pad, Roll-on pad							
Label applications	from the top	Blow-on pad, Roll-on pad, Corner-wrap pad							
	from below	Blow-on pad, Roll-on pad							
	from the side	Blow-on pad, Roll-on pad				-	Blow-on pad, Roll-on pad		
Distance of a package to the bottom of the unit	Blow-on pad up to mm	140	240	340	540	-	-	-	-
	Roll-on pad up to mm	160	260	360	560	160	260	360	560
	Corner-wrap pad up to mm	100	200	300	500	-	-	-	-
Package heights	uniform	Blow-on pad							
	variable	Blow-on pad, Corner-wrap pad							
Weight of applicator	packaging excluded kg	5	5	7	9	5.5	5.5	7.5	9,5
Consumption of power	W max.	15							
Compressed air	bar	4,5							
Cycle rate <sup>1)</sup>	labels/min approx.	25							

<sup>1)</sup> calculated using a stroke of 100 mm below the unit, labels 100 mm high, a print speed of 100 mm/s



### Blow-on pad

It benefits when labels have to be applied to sensitive surfaces or packages in motion. Labels are blown on by a blast of air. Stroke cylinder adjustment enables bridging distances of 5 to 10 mm to the surface of a package.



### Roll-on pad

Labels are rolled on plane surfaces while these packages are in motion.



### Corner-wrap pad

Labels are applied to a package on two sides adjacent to one another. One half of a label is applied to the top of a package. Then the other half of the label is rolled on.

Transfer modules			Blow-on pad 4014 L/R 2100	Roll-on pad 4014, 4016 L/R 4100	Corner-wrap pad 4014 L/R 5100
Label widths	HERMES Q4/Q4.3	mm	20 - 114	25 - 114	20 - 114
	HERMES Q6.3	mm	provided upon request	50 - 174	-
Label heights	HERMES Q4/Q4.3	mm	20 - 100	80 - 250	60 - 210
	HERMES Q6.3	mm	provided upon request	80 - 250	-

# Stroke applicators HQ 4024

- As much as 90 percent savings of compressed air
- Labels applied onto variable heights using one tamp pad

Labels are applied in real time onto packagings of different heights.

A spring-mounted print pad enables labels be applied reliably even onto inclined surfaces. Three vacuum pads are provided for labels 40 mm to 100 mm high, 150 mm and 200 mm. Label widths are 50 mm to 105 mm in each case.

Labels are sucked without supporting air by an electrically driven fan. Only the stroke cylinder requires compressed air.



## Accessories

### 5.14 Unit to regulate compressed air

## Options

### 5.17 Pressure-reducing valve



Stroke applicators		HQ 4024 L/R-200	HQ 4024 L/R-300	HQ 4024 L/R-400	HQ 4024 L/R-600
Distance of a package to the bottom of the unit	up to mm	135	235	335	535
Package heights	variable	■			
Alternation in the heights of packages	mm max.	100	200	300	500
Label applications		from the top, from below, from the side			from the top
State of a package at the moment a label is applied	at rest	■			
Controls	Sensor 1	initial / upper end position			
	Sensor 2	label on vacuum pad			
	Sensor 3	label application / lower end position			
Consumption of power	W max.	30			
Compressed air	bar	4.5			
Cycle rate <sup>1)</sup>	labels/min approx.	30			

<sup>1)</sup> calculated using a stroke of 100 mm below the unit, labels 40 mm high, a print speed of 100 mm/s

## Vacuum pad

Labels are precisely tamped on plane surfaces.

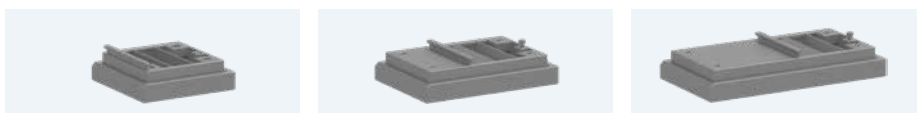

Vacuum pad			4024-3000 105 x 100	4024-3000 105 x 150	4024-3000 105 x 200
Label	Width	mm	50 - 105	50 - 105	50 - 105
	Height	mm	40 - 100	80 - 150	120 - 200
	Thickness	µm	110	110	110

# Stroke blow applicator HQ 4614

Labels can be applied in real time from all sides on packages of various heights in motion.

The pad locates in front of the peel-off plate. It picks up a label while it is being printed. Powered by a stroke cylinder and detected by a sensor, the pad moves to a spot approx. 10 mm above a package. The length of the stroke cylinder defines the maximum difference in terms of package heights.



## Accessories

5.13 **Blow tube**

5.14 **Unit to regulate compressed air**

4.10



Stroke blow applicator		HQ 4614 L/R-200	HQ 4614 L/R-300	HQ 4614 L/R-400
Distance of a package to the bottom of the unit	up to mm	140	240	340
Package heights	variable	■		
Label applications		from the top, from below, from the side		
State of a package at the moment a label is applied	at rest in motion	■ ■	■ ■	■ ■
Weight of applicator	packaging excluded kg	n.a.	5.5	6.5
Consumption of power	W max.		15	
Compressed air	bar		4.5	
Cycle rate <sup>1)</sup>	labels/min approx.		25	

<sup>1)</sup> calculated using a stroke of 100 mm below the unit, labels 100 mm high, a print speed of 100 mm/s

## Blow-on pad

Labels are blown on a package surface by a blast of air, bridging a distance of 5 to 10 mm.



Blow-on pad			4614L/R-2100 B x H
Label widths	HERMES Q4/Q4.3	mm	20 - 114
	HERMES Q6.3	mm	provided upon request
Label heights	HERMES Q4/Q4.3	mm	20 - 100
	HERMES Q6.3	mm	provided upon request

# Demand modules HQ 5112, HQ 5114, HQ 5116

Series of labels can be applied from all sides to packages in motion. The position to which apply a label can be defined on the dispenser tongue using a guide roller.

While a label is applied, the next one is printed simultaneously. Make sure the speed of the conveyor belt corresponds to the print speed.

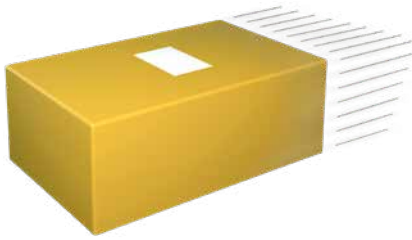

**Draw roller, made of steel**  
obligatory when operating  
a demand module

Demand module		HQ 5112 L/R	HQ 5114 L/R	HQ 5116 L/R
Label widths	HERMES Q2	10 - 58	-	-
	HERMES Q4/Q4.3	-	25 - 114	-
	HERMES Q6.3	-	-	46 - 174
Label heights	mm	10 - 250	25 - 250	
Distance of the print line to the peel-off plate	mm	400 - 600		
State of a package at the moment a label is applied	in motion	■		
Label applications		from the top, from below, from the side		
Package heights	uniform	■		
Distance of a package to the bottom of the unit	mm	80		
Package speeds	mm/s	must correspond to the print speed / 50 - 250 in steps of 25		
Weight of module	packaging excluded kg	not specified	3	7
Consumption of power	W max.	not specified		
Cycle rate <sup>1)</sup>	labels/min approx.	60		

<sup>1)</sup> calculated using labels 100 mm high and a print speed of 100 mm/s

# Vacuum belt applicators HQ 5314, HQ 5316

Labels can be applied in real time from all sides on plane surfaces to packages in motion.

The applicator locates in front of the peel-off plate. Printed labels are conveyed by a vacuum belt to the point of transfer to a package. Applying a label is triggered by an external signal.



Vacuum belt applicators		HQ 5314-2	HQ 5314-3	HQ 5314-4	HQ 5316-2	HQ 5316-3	HQ 5316-4
Label applications		on plane surfaces					
Directions to which dispense labels		left and right					
Label widths	HERMES Q4/Q4.3	mm	20 - 114	20 - 114	20 - 114	-	-
	HERMES Q6.3	mm	-	-	-	46 - 174	46 - 174
Label heights		mm	60 - 256	60 - 356	60 - 456	60 - 256	60 - 356
State of a package at the moment a label is applied	in motion	■					
Label applications		from the top, from below, from the side					
Package heights	uniform	■					
Package speeds	up to	m/s					
Gap between packages	at least	m					
Vacuum belt speed <sup>1)</sup>		mm/s					
Weight of applicator	packaging excluded	kg	7	7	7	8	8
Consumption of power	W max.	90					
Cycle rate <sup>2)</sup>	labels/min up to	30					
Distance of a label to the conveyor belt, when applying from the side	mm	Y = 20					

<sup>1)</sup> The speed of a package must be at least as high as the speed of the vacuum belt.

<sup>2)</sup> calculated using labels 100 mm high and a print speed of 250 mm/s

# Vacuum belt applicators HQ 5414, HQ 5416

Labels can be applied in real time from the top or from the side on cylindrical surfaces or corner-wrap to packages in motion.

The applicator locates in front of the peel-off plate. Printed labels are conveyed by a vacuum belt to the point of transfer to a package. Applying a label is triggered by an external signal.



Vacuum belt applicators			HQ 5414-3	HQ 5414-4	HQ 5416-3	HQ 5416-4
Label applications			on cylindrical surfaces and corner-wrap			
Directions to which dispense labels			left and right			
Label widths	HERMES Q4/Q4.3	mm	20 - 114	20 - 114	-	-
	HERMES Q6.3	mm	-	-	46 - 174	46 - 174
Label heights		mm	80 - 356	80 - 456	80 - 356	80 - 456
State of a package at the moment a label is applied		in motion	■			
Label applications			from the top, from the side			
Package heights	uniform		■			
	variable		■			
Package speeds		up to m/s	0.3			
Gap between packages		at least m	0.5			
Steadiness identified at the point a label is transferred			$F^1) = 30 \text{ N}$			
Corner-wrap label applications		up to mm	$X = 160$			
Vacuum belt speed <sup>2)</sup>		mm/s	100 - 300			
Weight of applicator	packaging excluded	kg	7	7	8.5	8.5
Consumption of power		W max.	90			
Cycle rate <sup>3)</sup>		labels/min up to	15			
Distance of a label to the conveyor belt, when applying from the side		mm	$Y = 20$			

<sup>1)</sup> F = force required to make the vacuum belt pivot

<sup>2)</sup> The speed of a package must be at least as high as the speed of the vacuum belt.

<sup>3)</sup> calculated using labels 100 mm high and a print speed of 250 mm/s

## Demand table HQ 5714

The demand table is a transfer module for the HERMES Q 4 in the left-hand version and enables printed and predisposed labels to be picked up by a robot. The labels are at rest during the pick-up process.

After printing and dispensing, the labels are placed over the extended Peel-off plate, adhesive side facing the dispensing table, ready for transfer to the robot stamp. The labels are at rest during removal. After removal, an automatic retraction can be performed on the printer.

The orientation of assembly of the system is designed for vertical removal.

Optionally, the printed label can be verified by a Scanner (provided by the customer) before it is transferred to the tamp pad. To support the label transfer to the print stamp, an optional chamber system with supporting air holes can be used.



Demand table		HQ 5714L-100
Label widths	mm	38-114
Label heights	mm	18-100
Orientation		left
Label during acceptance		at rest
Label material		Paper, plastics with release
Label application tolerance	mm	± 0.5
Compressed air	bar	no compressed air; 4.5 bar is an option
Cycle rate	labels/min up to	30

## Air jet box HQ 6114

Labels can be applied to packages in motion or at rest. Each label is sucked by a fan and blown off by a powerful blast of air coming through aligned nozzles. Depending from the size of a label, a maximum distance of 200 mm can be bridged between a package and the peel-off plate.

### 1 Template

to cover all the holes sucking or blowing off air outside a label

By holes pre-scored on an 8 x 8 mm pattern, a template can be adapted easily to the size of a label. By sliding in a template between the suction block and rails, the surface outside a label is covered. Scope of delivery includes five templates.

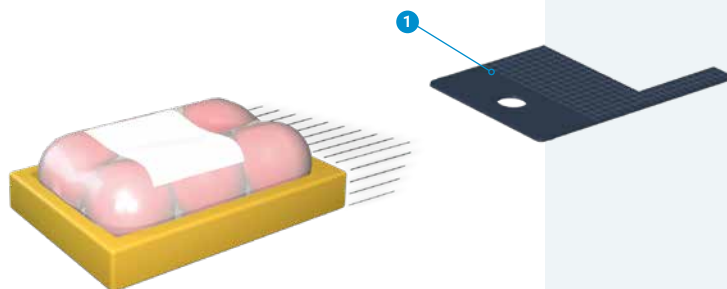

4.15



## Accessories

5.13 **Blow tube**

5.16 **Unit to regulate compressed air, providing a shut-off valve**

Air jet box		HQ 6114 L/R	
Label widths	HERMES Q4/Q4.3 mm	50-114	smaller sizes can be provided on request
Label heights	mm	50-125	smaller sizes can be provided on request
State of a package at the moment a label is applied	at rest in motion		■ ■
Label applications		from the top, from below, from the side	
Package heights	variable		■
Distance of a package to the peel-off plate	up to mm		200
Weight of air jet box	packaging excluded kg		4
Consumption of power	W max.		90
Compressed air	bar		4.5
Cycle rate <sup>1)</sup>	labels/min up to		100

<sup>1)</sup> calculated using labels 50 mm high, a print speed of 250 mm/s, a blast of air lasting 100 ms, with packages located 100 mm to the peel-off plate.

## Accessories provided for applicators

5.13



### Blow tube

to provide support air. To assist label transfer, the label is blown from below to the pad.

Provided for 2", 4" or 6" label applications

5.14



### Unit to regulate compressed air

4.5 bar default setting

Provided in a left-hand or right-hand design

Delivery includes a fine filter, a pressure control valve with a display, a hose to connect to an applicator's compressed air input and material to assemble the unit to a chassis or a bracket.

5.16



### Unit to regulate compressed air, providing a shut-off valve

to vent a hose line subsequent to the unit

Provided in a left-hand or right-hand design

## Examples how to assemble a unit to regulate compressed air

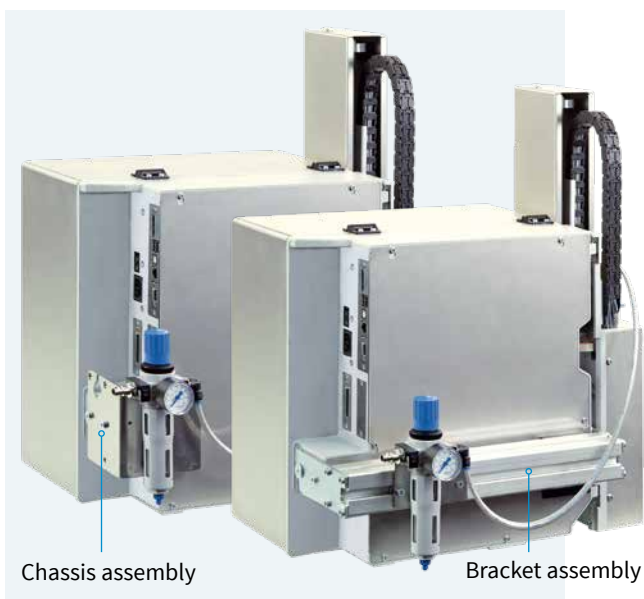

## Options provided for applicators

5.17



### **Pressure-reducing valve**

It reduces the pressure exerted by the stroke cylinder to a product.

5.18



### **Pressure-reduced applicator**

It has been designed for manual workstations missing a protective cover. The cylinder diameter is reduced to 12 mm. To prevent from injuries, a safety valve limits compressed air to a maximum of 4.8 bar.

# Tools for assembling HERMES Q

Pos.	Designation	1.1	1.2		1.3
		HERMES Q2	HERMES Q4.3	HERMES Q4	HERMES Q6.3
6.1	Adapter plate	<input type="checkbox"/>	<input type="checkbox"/>	<input type="checkbox"/>	<input type="checkbox"/>
6.2	Profiles 40, 80, 120, 160, 200, 300 mm	<input type="checkbox"/>	<input type="checkbox"/>	<input type="checkbox"/>	<input type="checkbox"/>
6.3	Base plate 500 x 255 mm	<input type="checkbox"/>	<input type="checkbox"/>	<input type="checkbox"/>	-
6.4	Base plate with XY Stop and product sensor	<input type="checkbox"/>	<input type="checkbox"/>	<input type="checkbox"/>	-



## Mount

to install on a table or to a production line.  
Provided in a left-hand or right-hand design

The size of the mount can be adapted to an application.

6.1



### 1 Adapter plate

to fix a label application system.

Alternatively, it can be assembled directly to a production line, using the adapter plate with a profile.

6.2



### 2 Profile

square aluminum; 40, 80, 120, 160, 200, 30 mm are standards, further lengths can be provided on request

6.3



### 3 Base plate

to fix the product jig; 500 x 255 mm by default

6.4



### 4 Base plate with XY stop and product sensor

Standard size 500 x 255 mm

## Tools for assembling HERMES Q

Pos.	Designation	1.1	1.2		1.3
		HERMES Q2	HERMES Q4.3	HERMES Q4	HERMES Q6.3
6.5	Bracket	<input type="checkbox"/>	<input type="checkbox"/>	<input type="checkbox"/>	<input type="checkbox"/>
6.6	Clamped joint designed for a 50 x 50 mm profile	<input type="checkbox"/>	<input type="checkbox"/>	<input type="checkbox"/>	<input type="checkbox"/>
6.7	Flanged joint designed for a 50 x 50 mm profile	<input type="checkbox"/>	<input type="checkbox"/>	<input type="checkbox"/>	<input type="checkbox"/>
6.8	Floor stand 1601	<input type="checkbox"/>	<input type="checkbox"/>	<input type="checkbox"/>	<input type="checkbox"/>
6.9	Floor stand 1602	<input type="checkbox"/>	<input type="checkbox"/>	<input type="checkbox"/>	<input type="checkbox"/>
6.10	Floor stand 1201	<input type="checkbox"/>	<input type="checkbox"/>	<input type="checkbox"/>	<input type="checkbox"/>



**Bracket**  
to assemble to a floor stand

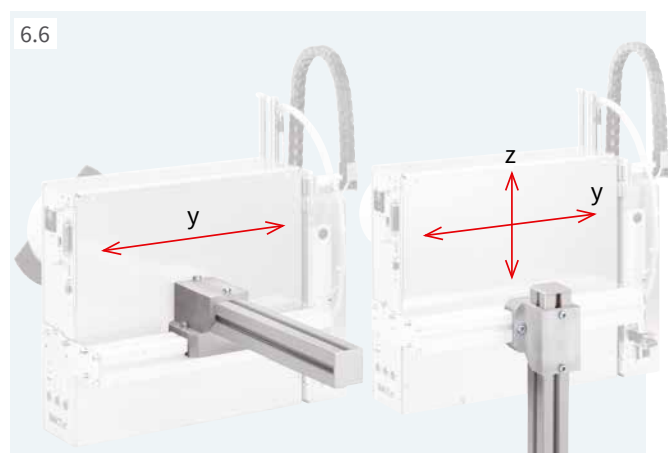

**Clamped joint designed for a 50 x 50 mm profile**  
to move in horizontal or vertical direction

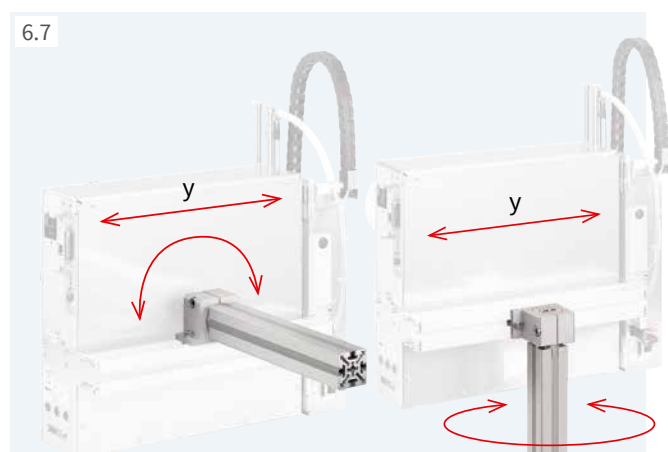

**Flanged joint designed for a 50 x 50 mm profile**  
to move in horizontal direction or rotate around an axis

# Floor stands provided for HERMES Q

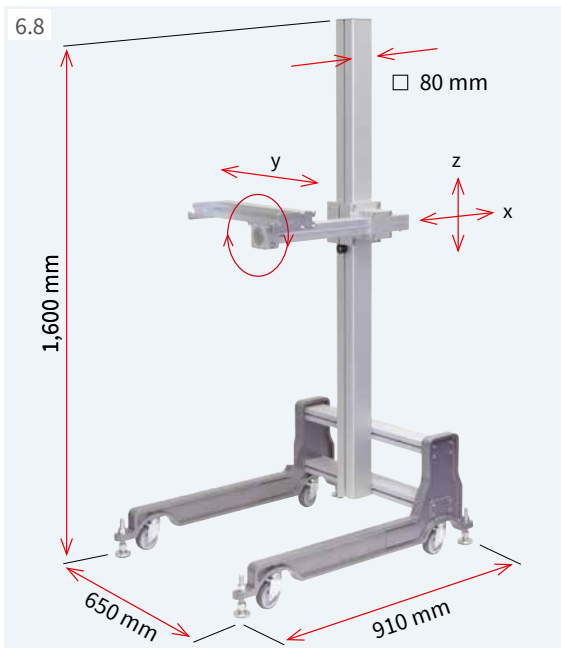

HERMES Q can be installed to a production line and aligned in three axes to the product to label. Pivoting is also possible.

### Floor stand 1601

It benefits when operating HERMES Q in different production lines. Mobility is provided. At the place of operation, the floor stand can be fixed with the help of feet to adjust.

Floor stand	1601
Base frame	castors, feet
Adjustment of heights and depths	screw clamping
Load if offset is 500 mm	up to kg
Weight	kg

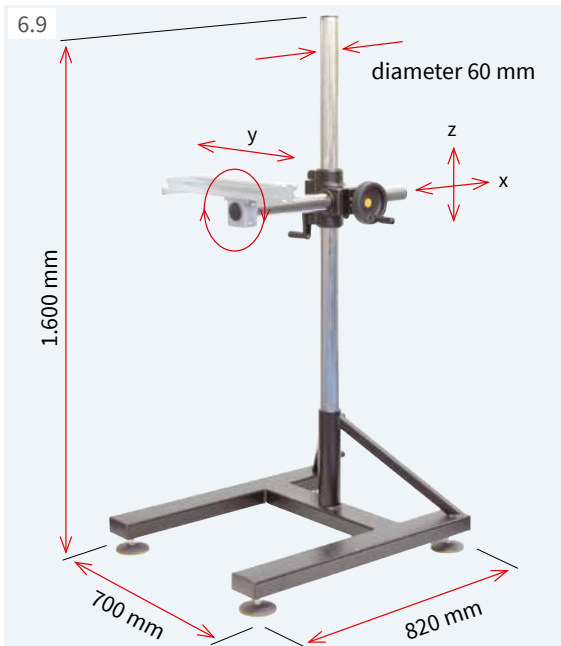

### Floor stand 1602

It benefits if positions to apply labels are changing frequently in terms of heights and depths. HERMES Q can be aligned in directions x and z to a product using a toothed rack.

Floor stand	1602
Base frame	feet
Adjustment of heights and depths	toothed rack, crank toothed rack, handwheel
Load if offset is 500 mm	up to kg
Weight	kg

## Examples how to assemble to a stand

Applying labels in direction of transport  
from the top                      from the side

Applying labels crosswise the direction of transport  
from the top                      from the side

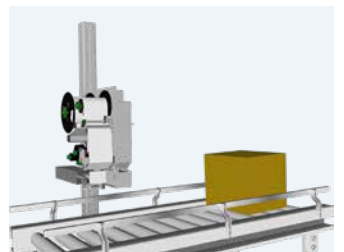
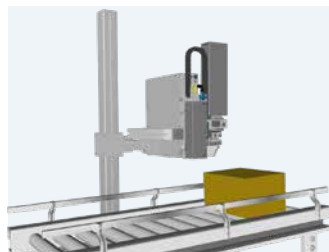
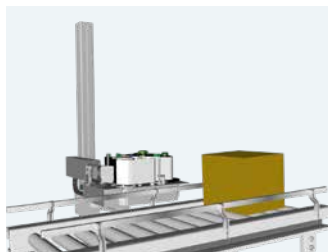
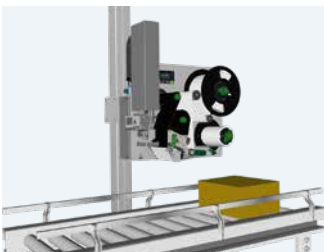

## HERMES Q floor stand

6.10

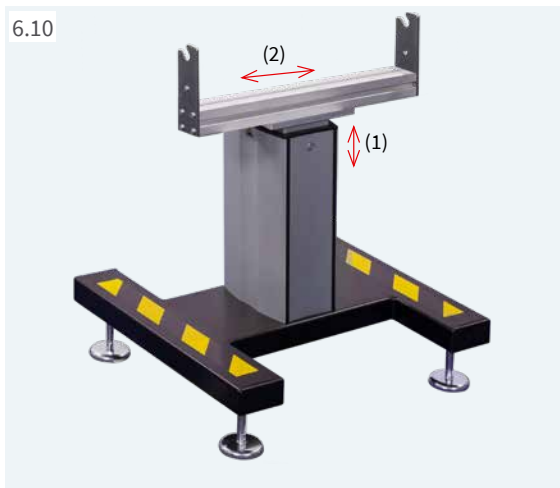

### Floor stand 1201

to assemble HERMES Q horizontally in a production line.

The height can be adjusted continuous using an integral spindle.

A unit to regulate compressed air can be assembled to the bracket, so can a warning light.

Floor stand		1201
Feet to adjust	by mm	± 15
Load	up to kg	75
(1) Lower label margin-floor <sup>1)</sup>	mm	720-960
(2) Depth along direction of transport	mm	± 100
Weight	approx. kg	40

<sup>1)</sup> further dimensions can be provided on request

# HERMES Q delivery program

## Label printers L

Pos.	Part no.	Designation
1.1	<b>6010003</b>	Label printer HERMES Q2L/300-2
	<b>6010004</b>	Label printer HERMES Q2L/600-2
1.2	<b>6010005</b>	Label printer HERMES Q4L/300-2
	<b>6010006</b>	Label printer HERMES Q4L/600-2
	<b>6010007</b>	Label printer HERMES Q4.3L/200-2
	<b>6010008</b>	Label printer HERMES Q4.3L/300-2
1.3	<b>6010009</b>	Label printer HERMES Q6.3L/200-2
	<b>6010010</b>	Label printer HERMES Q6.3L/300-2
1.1	<b>6010011</b>	Label printer HERMES Q2L/300-3
	<b>6010012</b>	Label printer HERMES Q2L/600-3
1.2	<b>6010013</b>	Label printer HERMES Q4L/300-3
	<b>6010014</b>	Label printer HERMES Q4L/600-3
	<b>6010015</b>	Label printer HERMES Q4.3L/200-3
	<b>6010016</b>	Label printer HERMES Q4.3L/300-3
	<b>6010017</b>	Label printer HERMES Q6.3L/200-3
1.3	<b>6010018</b>	Label printer HERMES Q6.3L/300-3

xxxxxxx.250 if HERMES Q provides options

## Label printers R

Pos.	Part no.	Designation
1.1	<b>6010023</b>	Label printer HERMES Q2R/300-2
	<b>6010024</b>	Label printer HERMES Q2R/600-2
1.2	<b>6010025</b>	Label printer HERMES Q4R/300-2
	<b>6010026</b>	Label printer HERMES Q4R/600-2
	<b>6010027</b>	Label printer HERMES Q4.3R/200-2
	<b>6010028</b>	Label printer HERMES Q4.3R/300-2
1.3	<b>6010029</b>	Label printer HERMES Q6.3R/200-2
	<b>6010030</b>	Label printer HERMES Q6.3R/300-2
1.1	<b>6010031</b>	Label printer HERMES Q2R/300-3
	<b>6010032</b>	Label printer HERMES Q2R/600-3
1.2	<b>6010033</b>	Label printer HERMES Q4R/300-3
	<b>6010034</b>	Label printer HERMES Q4R/600-3
	<b>6010035</b>	Label printer HERMES Q4.3R/200-3
	<b>6010036</b>	Label printer HERMES Q4.3R/300-3
	<b>6010037</b>	Label printer HERMES Q6.3R/200-3
1.3	<b>6010038</b>	Label printer HERMES Q6.3R/300-3

xxxxxxx.250 if HERMES Q provides options

### Scope of HERMES Q label printer delivery

HERMES Q label printer  
Power cable Type E+F, 1.8 m  
Connecting USB cable, 1.8 m  
Assembly instructions DE/EN

### Provided online



Assembly instructions DE/EN/FR  
Configuration manuals DE/EN/FR  
Service manuals DE/EN  
Spare parts lists DE/EN  
Programming manual EN  
Windows printer drivers certified WHQL for  
Windows 10 Server 2016  
Windows 11 Server 2019  
Server 2022

<https://setup.cab.de/en>

Apple Mac OS X printer drivers DE/EN/FR  
Linux printer drivers DE/EN/FR  
cablabel S3 Lite software  
cablabel S3 Viewer  
Database Connector

## Options

Pos.	Part no.	Designation
3.1	<b>6010860.250</b>	Automatic ribbon saving 4L
	<b>6010861.250</b>	Automatic ribbon saving 6L
3.2	<b>6010862.250</b>	Automatic ribbon saving 4R
	<b>6010863.250</b>	Automatic ribbon saving 6R
3.2	<b>xxxxxxx.486</b>	UHF RFID/4/6.3 RS module
	<b>xxxxxxx.488</b>	UHF RFID/4/6.3 HS module
3.3	<b>6010591.xxx</b>	Label unwinder K40/2-2
	<b>6010592.xxx</b>	Label unwinder K40/4-2
	<b>6010593.xxx</b>	Label unwinder K40/6-2
	<b>6010594.xxx</b>	Label unwinder K40/2-3
	<b>6010595.xxx</b>	Label unwinder K40/4-3
3.4	<b>5961406.xxx</b>	Adapter 40/50
3.5	<b>5961262.xxx</b>	Adapter 76/100
3.6	<b>6010586.xxx</b>	Spacer Q L-2
	<b>6010590.xxx</b>	Spacer Q R-2
	<b>6010905.xxx</b>	Spacer Q L-3
	<b>6010906.xxx</b>	Spacer Q R-3
3.7	<b>5961650.xxx</b>	Margin stop 10
3.8	<b>6010500.xxx</b>	Cover 2L F60
	<b>6010933.xxx</b>	Cover 2L F100
	<b>6010501.xxx</b>	Cover 4L F60
	<b>6010937.xxx</b>	Cover 4L F100
	<b>6010502.xxx</b>	Cover 6L F25
	<b>6010503.xxx</b>	Cover 2R F60
	<b>6010939.xxx</b>	Cover 2R F100
	<b>6010504.xxx</b>	Cover 4R F60
	<b>6010941.xxx</b>	Cover 4R F100
	<b>6010505.xxx</b>	Cover 6R F25
3.9	<b>6010840.xxx</b>	Print head pressure system 2L
	<b>6010841.xxx</b>	Print head pressure system 4L
	<b>6010842.xxx</b>	Print head pressure system 6L
	<b>6010843.xxx</b>	Print head pressure system 2R
	<b>6010844.xxx</b>	Print head pressure system 4R
	<b>6010845.xxx</b>	Print head pressure system 6R
3.10	<b>6010557.xxx</b>	Extended peel-off plate (+10 mm) 2L
	<b>6010558.xxx</b>	Extended peel-off plate (+10 mm) 4L
	<b>6010559.xxx</b>	Extended peel-off plate (+10 mm) 6L
	<b>6010563.xxx</b>	Extended peel-off plate (+10 mm) 2R
	<b>6010564.xxx</b>	Extended peel-off plate (+10 mm) 4R
	<b>6010565.xxx</b>	Extended peel-off plate (+10 mm) 6R
3.11	<b>5954978.xxx</b>	Print roller DRS2
	<b>5954985.xxx</b>	Print roller DRS4
	<b>5954979.xxx</b>	Print roller DRS6
3.12	<b>5961640.xxx</b>	Antistatic brush 2L
	<b>5961644.xxx</b>	Antistatic brush 4L
	<b>5961642.xxx</b>	Antistatic brush 2R
	<b>5961646.xxx</b>	Antistatic brush 4R
3.13	<b>5961750.xxx</b>	Draw roller ZS2
	<b>5961751.xxx</b>	Draw roller ZS4
	<b>5961752.xxx</b>	Draw roller ZS6
3.14	<b>5591816.xxx</b>	Interface for plugging an external label sensor
3.15	<b>6010520.xxx</b>	2 port Ethernet switch 10/100 Mbit/s
3.16	<b>5977487.xxx</b>	Label sensor L, modified
	<b>6010498.xxx</b>	Label sensor R, modified

xxx - .250 assembled to the printer  
.001 delivered separately



Informations are available also on the Internet:  
[www.cab.de/en/hermesq](http://www.cab.de/en/hermesq)

# HERMES Q delivery program



## Accessories

Pos.		Part no.	Designation
2.1		5977370	SD memory card
2.2		5977730	USB memory stick
2.3		5978912	USB WLAN stick 2.4 GHz 802.11b/g/n
2.4		5977731	USB WLAN stick including a rod antenna 2.4 GHz 802.11b/g/n + 5 GHz a/n/ac
2.6		5970071	Product sensor, 3 pins
2.7		5964300	Product sensor, 25 pins
2.8		5917651	I/O interface connector SUB-D, 25 pins
2.9		6010560	Warning light
2.10		6010186	External operation panel
		5907718.850	Connecting USB cable, 1.8 m
		5907730.850	Connecting USB cable, 3 m
		5907750.850	Connecting USB cable, 5 m
		5907760.850	Connecting USB cable, 11 m
5907765.850	Connecting USB cable, 16 m		
2.11		5948205	Label selection - I/O box
2.12		5955710	Hand switch TR2
2.13		5955711	Foot switch
2.14		5550818	Connecting RS232 C cable 9/9 pins, 3 m
2.15		on request	Scanner CC200

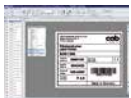
## Label software

Pos.		Part no.	Designation
7.6		Bundle	cablabel S3 Lite (download on cab.de/en)
		5588001	cablabel S3 Pro, 1 WS
		5588100	cablabel S3 Pro, 5 WS
		5588101	cablabel S3 Pro, 10 WS
		5588150	cablabel S3 Pro, 1 additional licence
		5588151	cablabel S3 Pro, 4 additional licences
		5588152	cablabel S3 Pro, 9 additional licences
		5588002	cablabel S3 Print, 1 WS
		5588105	cablabel S3 Print, 5 WS
		5588106	cablabel S3 Print, 10 WS
		5588155	cablabel S3 Print, 1 additional licence
		5588156	cablabel S3 Print, 4 additional licences
5588157	cablabel S3 Print, 9 additional licences		
		in preparation	cablabel S3 Print Server
7.10		9008486	Programming manual EN, printed copy

## Wear parts

Pos.		Part no.	Designation
		5977384.001	Print head 2/300
		5977385.001	Print head 2/600
		5977444.001	Print head 4/300
		5977380.001	Print head 4/600
		5977382.001	Print head 4.3/200
		5977383.001	Print head 4.3/300
		5977386.001	Print head 6.3/200
		5977387.001	Print head 6.3/300
		5954102.001	Print roller DR2
		5954180.001	Print roller DR4
		5954245.001	Print roller DR6
		5961015.001	Draw roller ZR2
		5961298.001	Draw roller ZR4
		5961220.001	Draw roller ZR6















## User languages

Language	Assembly instructions	Control panel	Windows driver	Service manual	cablabel S3
<b>European Union</b>					
Bulgarian		X	X		X
Danish	X	X	X		
German	X	X	X	X	X
Estonian		X	X		
Finnish	X	X	X		
French	X	X	X		X
Greek		X	X		
English	X	X	X	X	X
Italian	X	X	X		X
Croatian		X	X		
Latvian		X	X		
Lithuanian		X	X		
Dutch	X	X	X		
Polish	X	X	X		X
Portuguese	X	X	X		
Romanian	X	X	X		
Swedish	X	X	X		
Slovak		X	X		
Slovenian	X	X	X		
Spanish	X	X	X		X
Czech	X	X	X		X
Hungarian	X	X	X		
<b>Europe (Non-EU)</b>					
Macedonian		X	X		
Norwegian		X	X		
Russian	X	X	X		X
Serbian		X	X		
Turkish		X	X		
<b>Asia</b>					
Chinese (simplified)	X	X	X		X
Chinese (traditional)	X	X	X		X
Japanese		X	X		
Korean	X	X	X		X
Thai		x	X		
<b>Middle East</b>					
Arabian		X			
Persian		X			

Scopes of delivery, design and technical specifications correspond to the date of the printing. Subject to change. The data provided in the catalog do not represent any warranty or guarantee.

# HERMES Q delivery program













## Applicators L

Pos.	Part no.	Designation	Part no.	Transfer modules
4.1	 <b>5987532</b>	Swing applicator HQ 3214L-40	xxxxxxx xxxxxxx xxxxxxx xxxxxxx	Tamp-on pad 3214L-11 F W x H Tamp-on pad, providing a damping layer 3214L-12 F W x H Tamp-on pad, providing a label stop 3214L-61 F W x H Blow-on pad 3214L-2100 W x H
4.2	 <b>5987549</b> <b>5987550</b> <b>5987551</b> <b>5989352</b>	Stroke applicator HQ 4114L-200 Stroke applicator HQ 4114L-300 Stroke applicator HQ 4114L-400 Stroke applicator HQ 4114L-600	xxxxxxx xxxxxxx xxxxxxx xxxxxxx	Tamp-on pad 4114L-11 F W x H Tamp-on pad, providing a damping layer 4114L-12 F W x H Tamp-on pad, providing a label stop 4114L-61 F W x H Blow-on pad 4114L-2100 W x H Form pad 4114L-8800 W x H
		<b>5987802</b> <b>5987803</b> <b>5987804</b>	Stroke applicator HQ 4116L-200 Stroke applicator HQ 4116L-300 Stroke applicator HQ 4116L-400	xxxxxxx xxxxxxx xxxxxxx xxxxxxx
4.3	 <b>5987557</b> <b>5987558</b> <b>5987559</b>	Stroke turn applicator HQ 4214L-200 Stroke turn applicator HQ 4214L-300 Stroke turn applicator HQ 4214L-400	xxxxxxx xxxxxxx xxxxxxx xxxxxxx	Tamp-on pad 4214L-11 F W x H Tamp-on pad, providing a damping layer 4214L-12 F W x H Tamp-on pad, providing a label stop 4214L-61 F W x H Blow-on pad 4214L-2100 W x H
4.4	 <b>5987573</b> <b>5987574</b> <b>5987575</b>	Stroke applicator HQ 4414L-200 Stroke applicator HQ 4414L-300 Stroke applicator HQ 4414L-400	xxxxxxx xxxxxxx xxxxxxx	Tamp-on pad 4414L-11 F W x H Tamp-on pad, providing a damping layer 4414L-12 F W x H Tamp-on pad, providing a label stop 4414L-61 F W x H
4.5	 <b>5987724</b> <b>5987726</b> <b>5987728</b>	Swing stroke applicator HQ 4514L-200 Swing stroke applicator HQ 4514L-300 Swing stroke applicator HQ 4514L-400	xxxxxxx	Blow-on pad 4514L-2100 W x H
4.6	 <b>5987548</b>	Flag applicator HQ 4712L-300	xxxxxxx	Form pad ..... W x H
4.7	 <b>5987520</b> <b>5987521</b> <b>5987522</b> <b>5989343</b>	Front side applicator HQ 3014L-200 Front side applicator HQ 3014L-300 Front side applicator HQ 3014L-400 Front side applicator HQ 3014L-600	xxxxxxx xxxxxxx xxxxxxx xxxxxxx	Tamp-on pad 3014L-1100 W x H Tamp-on pad, spring-mounted 3014L-3100 W x H Blow-on pad 3014L-2100 W x H
		<b>5987523</b> <b>5987524</b> <b>5987525</b> <b>5989346</b>	Front side applicator HQ 3016L-200 Front side applicator HQ 3016L-300 Front side applicator HQ 3016L-400 Front side applicator HQ 3016L-600	xxxxxxx xxxxxxx xxxxxxx xxxxxxx
4.8	 <b>5987534</b> <b>5987535</b> <b>5987536</b> <b>5987537</b>	Stroke applicator HQ 4014L-200 Stroke applicator HQ 4014L-300 Stroke applicator HQ 4014L-400 Stroke applicator HQ 4014L-600	<b>5966147</b> <b>5966148</b> <b>5966149</b> <b>5966150</b>	Universal pad 4014L-1100 75 x 60 Universal pad 4014L-1100 90 x 90 Universal pad, spring-mounted 4014L-3100 116 x 102 Universal pad, spring-mounted 4014L-3100 116 x 152
		<b>5987541</b> <b>5987542</b> <b>5987543</b> <b>5989344</b>	Stroke applicator HQ 4016L-200 Stroke applicator HQ 4016L-300 Stroke applicator HQ 4016L-400 Stroke applicator HQ 4016L-600	xxxxxxx xxxxxxx xxxxxxx xxxxxxx
4.9	 <b>5989285</b> <b>5989286</b> <b>5989287</b> <b>5989288</b>	Stroke applicator HQ 4024L-200 Stroke applicator HQ 4024L-300 Stroke applicator HQ 4024L-400 Stroke applicator HQ 4024L-600	<b>5989301</b> <b>5989302</b> <b>5989303</b>	Vacuum pad 4024-3000 105 x 100 Vacuum pad 4024-3000 105 x 150 Vacuum pad 4024-3000 105 x 200
		<b>5987736</b> <b>5987738</b> <b>5987740</b>	Stroke blow applicator HQ 4614L-200 Stroke blow applicator HQ 4614L-300 Stroke blow applicator HQ 4614L-400	xxxxxxx
4.11	 <b>6010890</b> <b>5966144</b> <b>5966146</b>	Demand module HQ 5112L Demand module HQ 5114L Demand module HQ 5116L		
4.12	 <b>5972870</b> <b>5987552</b> <b>5989291</b> <b>5989292</b>	Vacuum belt applicator HQ 5314L-2 Vacuum belt applicator HQ 5314L-3 Vacuum belt applicator HQ 5314L-4 Vacuum belt applicator HQ 5316L-2		
		<b>5987710</b> <b>5989293</b>	Vacuum belt applicator HQ 5316L-3 Vacuum belt applicator HQ 5316L-4	
4.13	 <b>5987714</b> <b>5989294</b> <b>5987718</b> <b>5987720</b>	Vacuum belt applicator HQ 5414L-3 Vacuum belt applicator HQ 5414L-4 Vacuum belt applicator HQ 5416L-3 Vacuum belt applicator HQ 5416L-4		
4.14	 <b>6011850</b>	Demand table HQ 5714L-100		
4.15	 <b>5987564</b>	Air jet box 5 templates are included HQ 6114L	<b>5984709.001</b>	Template 5 items are included in a pack unit 6114 L/R

xxxxxxx - customer-specific part no. subsequent to request



# HERMES Q delivery program

## Applicators R



Pos.		Part no.	Designation		Part no.	Transfer modules
4.1		<b>5987533</b>	Swing applicator	HQ3214R-40	xxxxxxx xxxxxxx xxxxxxx xxxxxxx	Tamp-on pad 3214L-11 F W x H Tamp-on pad, providing a damping layer 3214L-12 F W x H Tamp-on pad, providing a label stop 3214L-61 F W x H Blow-on pad 3214L-2100 W x H
4.2		<b>5987553</b>	Stroke applicator	HQ 4114R-200	xxxxxxx	Tamp-on pad 4114L-11 F W x H
		<b>5987554</b>	Stroke applicator	HQ 4114R-300	xxxxxxx	Tamp-on pad, providing a damping layer 4114L-12 F W x H
		<b>5987555</b>	Stroke applicator	HQ 4114R-400	xxxxxxx	Tamp-on pad, providing a label stop 4114L-61 F W x H
		<b>5989353</b>	Stroke applicator	HQ 4114R-600	xxxxxxx xxxxxxx	Blow-on pad 4114L-2100 W x H Form pad 4114L-8800 W x H
		<b>5987812</b>	Stroke applicator	HQ 4116R-200	xxxxxxx	Tamp-on pad 4116L-11 F W x H
		<b>5987813</b>	Stroke applicator	HQ 4116R-300	xxxxxxx	Tamp-on pad, providing a damping layer 4116L-12 F W x H
		<b>5987814</b>	Stroke applicator	HQ 4116R-400	xxxxxxx xxxxxxx	Tamp-on pad, providing a label stop 4116L-61 F W x H Form pad 4116L-8800 W x H
4.3		<b>5987561</b>	Stroke turn applicator	HQ 4214R-200	xxxxxxx	Tamp-on pad 4214L-11 F W x H
		<b>5987562</b>	Stroke turn applicator	HQ 4214R-300	xxxxxxx	Tamp-on pad, providing a damping layer 4214L-12 F W x H
		<b>5987563</b>	Stroke turn applicator	HQ 4214R-400	xxxxxxx xxxxxxx	Tamp-on pad, providing a label stop 4214L-61 F W x H Blow-on pad 4214L-2100 W x H
4.4		<b>5987577</b>	Stroke applicator	HQ 4414R-200	xxxxxxx	Tamp-on pad 4414L-11 F W x H
		<b>5987578</b>	Stroke applicator	HQ 4414R-300	xxxxxxx	Tamp-on pad, providing a damping layer 4414L-12 F W x H
		<b>5987579</b>	Stroke applicator	HQ 4414R-400	xxxxxxx	Tamp-on pad, providing a label stop 4414L-61 F W x H
4.5		<b>5987730</b>	Swing stroke applicator	HQ 4514R-200	xxxxxxx	Blow-on pad 4514L-2100 W x H
		<b>5987732</b>	Swing stroke applicator	HQ 4514R-300		
		<b>5987734</b>	Swing stroke applicator	HQ 4514R-400		
4.7		<b>5987526</b>	Front side applicator	HQ 3014R-200	xxxxxxx	Tamp-on pad 3014L-1100 W x H
		<b>5987527</b>	Front side applicator	HQ 3014R-300	xxxxxxx	Tamp-on pad, spring-mounted 3014L-3100 W x H
		<b>5987528</b>	Front side applicator	HQ 3014R-400	xxxxxxx	Blow-on pad 3014L-2100 W x H
		<b>5989354</b>	Front side applicator	HQ 3014R-600		
		<b>5987529</b>	Front side applicator	HQ 3016R-200		
		<b>5987530</b>	Front side applicator	HQ 3016R-300	xxxxxxx	Tamp-on pad 3016L-1100 W x H
4.8		<b>5987531</b>	Front side applicator	HQ 3016R-400	xxxxxxx	Tamp-on pad, spring-mounted 3016L-3100 W x H
		<b>5989355</b>	Front side applicator	HQ 3016R-600		
		<b>5987538</b>	Stroke applicator	HQ 4014R-200	<b>5966140</b>	Universal pad 4014L-1100 75 x 60
		<b>5987539</b>	Stroke applicator	HQ 4014R-300	<b>5966141</b>	Universal pad 4014L-1100 90 x 90
		<b>5987540</b>	Stroke applicator	HQ 4014R-400	<b>5966142</b>	Universal pad, spring-mounted 4014L-3100 116 x 102
		<b>5989363</b>	Stroke applicator	HQ 4014R-600	<b>5966143</b>	Universal pad, spring-mounted 4014L-3100 116 x 152
4.8					xxxxxxx	Tamp-on pad 4014L-11 F W x H
					xxxxxxx	Blow-on pad 4014L-2100 W x H
					xxxxxxx	Tamp-on pad, spring-mounted 4014L-3100 W x H
					xxxxxxx	Roll-on pad 4014L-4100 W x H
					xxxxxxx	Corner-wrap pad 4014L-5100 W x H / H
		<b>5987545</b>	Stroke applicator	HQ 4016R-200	xxxxxxx	Tamp-on pad 4016R-11 F W x H
<b>5987546</b>	Stroke applicator	HQ 4016R-300	xxxxxxx	Tamp-on pad, spring-mounted 4016R-3100 W x H		
<b>5987547</b>	Stroke applicator	HQ 4016R-400	xxxxxxx	Roll-on pad 4016R-4100 W x H		
<b>5989356</b>	Stroke applicator	HQ 4016R-600	xxxxxxx	Roll-on pad 4016R-4100 W x H		
4.9		<b>5989295</b>	Stroke applicator	HQ 4024R-200	<b>5989301</b>	Vacuum pad 4024-3000 105 x 100
		<b>5989296</b>	Stroke applicator	HQ 4024R-300	<b>5989302</b>	Vacuum pad 4024-3000 105 x 150
		<b>5989297</b>	Stroke applicator	HQ 4024R-400	<b>5989303</b>	Vacuum pad 4024-3000 105 x 200
		<b>5989298</b>	Stroke applicator	HQ 4024R-600		
4.10		<b>5987742</b>	Stroke blow applicator	HQ 4614R-200	xxxxxxx	Blow-on pad 4614L-2100 W x H
		<b>5987744</b>	Stroke blow applicator	HQ 4614R-300		
		<b>5987746</b>	Stroke blow applicator	HQ 4614R-400		
4.11		<b>6010910</b>	Demand module	HQ 5112R		
		<b>5966145</b>	Demand module	HQ 5114R		
		<b>5966152</b>	Demand module	HQ 5116R		
4.12		<b>5987708</b>	Vacuum belt applicator	HQ 5314R-2		
		<b>5987556</b>	Vacuum belt applicator	HQ 5314R-3		
		<b>5989357</b>	Vacuum belt applicator	HQ 5314R-4		
		<b>5989358</b>	Vacuum belt applicator	HQ 5316R-2		
		<b>5987712</b>	Vacuum belt applicator	HQ 5316R-3		
4.13		<b>5989359</b>	Vacuum belt applicator	HQ 5316R-4		
		<b>5987716</b>	Vacuum belt applicator	HQ 5414R-3		
		<b>5989360</b>	Vacuum belt applicator	HQ 5414R-4		
		<b>5987722</b>	Vacuum belt applicator	HQ 5416R-3		
		<b>5989361</b>	Vacuum belt applicator	HQ 5416R-4		
4.15		<b>5987565</b>	Air jet box 5 templates are included	HQ 6114R	<b>5984709.001</b>	Template 5 items are included in a pack unit 6114 L/R

xxxxxxx - customer-specific part no. subsequent to request







## Accessories provided for applicators

Pos.		Part no.	Designation
5.13		<b>5964277.001</b>	Blow tube 2"
		<b>5964095.001</b>	Blow tube 4"
		<b>5964614.001</b>	Blow tube 6"
5.14		<b>6010880</b> <b>6010881</b>	Unit L to regulate compressed air Unit R to regulate compressed air
5.16		<b>5984805</b> <b>5984795</b>	Unit L to regulate compressed air, providing a shut-off valve Unit R to regulate compressed air, providing a shut-off valve

## Options provided for applicators

Pos.		Part no.	Designation
5.17		<b>596xxxx.212</b>	Pressure-reducing valve
		xxxx - applicator part no.	
5.18		<b>596xxxx.220</b>	Pressure-reduced applicator suitable for HQ 4014, HQ 4114, HQ 4414, HQ 4214 / 300 stroke
		xxxx - applicator part no.	

## Tools for assembly

Pos.		Part no.	Designation
6.1		<b>5965940</b>	Adapter plate
6.2		<b>5958365</b> <b>5965929</b> <b>5971721</b> <b>5987701</b> <b>5987702</b> <b>5987703</b>	Profile 40 Profile 80 Profile 120 Profile 160 Profile 200 Profile 300
6.3		<b>5961203</b>	Base plate 500 x 255 mm
6.4		<b>5989277</b>	Base plate with XY Stop and product sensor
6.5		<b>5955685</b>	Bracket
6.6		<b>8914443</b>	Clamped joint designed for a 50 x 50 mm profile
6.7		<b>8914444</b>	Flanged joint designed for a 50 x 50 mm profile

## Floor stands

Pos.		Part no.	Designation
6.8		<b>5970113</b>	Floor stand 1601
6.9		<b>5970112</b>	Floor stand 1602
6.10		<b>5972515</b>	Floor stand 1201

# Overview of cab products

Label printers  
**MACH1, MACH2**



Label printers  
**EOS 2**



Label printers  
**EOS 5**



Label printers  
**MACH 4S**



Label printers  
**SQUIX 2**



Label printers  
**SQUIX 4**



Label printers  
**SQUIX 6.3**



Label printers  
**SQUIX 8.3**



Label printers  
**XD Q double-sided**



Label printers  
**XC Q two-colored**



Print and apply systems  
**HERMES Q**



Print and apply systems  
**Hermes C two-colored**

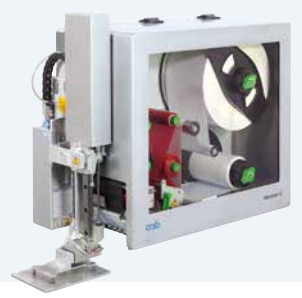

Tube labeling systems  
**AXON 1**



Print modules  
**PX Q**



Labels and ribbons



Label software  
**cablabel S3**



Label dispensers  
**HS, VS**



Labeling heads  
**IXOR**



Marking lasers  
**XENO 4**



Laser marking systems



Germany

**cab Produkttechnik GmbH & Co KG**

Karlsruhe

Phone +49 721 6626 0

[www.cab.de](http://www.cab.de)

France

**cab Technologies S.à.r.l.**

Niedermodern

Phone +33 388 722501

[www.cab.de/fr](http://www.cab.de/fr)

USA

**cab Technology, Inc.**

Chelmsford, MA

Phone +1 978 250 8321

[www.cab.de/us](http://www.cab.de/us)

Mexico

**cab Technology, Inc.**

Juárez

Phone +52 656 682 4301

[www.cab.de/es](http://www.cab.de/es)

Taiwan

**cab Technology Co., Ltd.**

Taipei

Phone +886 (02) 8227 3966

[www.cab.de/tw](http://www.cab.de/tw)

China

**cab (Shanghai) Trading Co., Ltd.**

Shanghai

Phone +86 (021) 6236 3161

[www.cab.de/cn](http://www.cab.de/cn)

Singapore

**cab Singapore Pte. Ltd.**

Singapore

Phone +65 6931 9099

[www.cab.de/en](http://www.cab.de/en)

South Africa

**cab Technology (Pty) Ltd.**

Randburg

Phone +27 11 886 3580

[www.cab.de/za](http://www.cab.de/za)

**cab // 820** distribution and service partners in more than **80** countries